

Latynflex
CONEXIONES FLEXIBLES

CONEXIONES FLEXIBLES

CONEXIONES FLEXIBLES PARA AGUA Y GAS

GAS
FLEXIBLE MALLADO ACERO INOXIDABLE - GAS LICUADO

MODELO	AF GAS-2600	CÓDIGO	MEDIDA	G (mm)	C (mm)	E (mm)	H (mm)	D (mm)	L (mm)
		1926001230	1/2x30	1/2" M	7,5	13,5	1/2" H	7,5	300
		1926001240	1/2x40	1/2" M	7,5	13,5	1/2" H	7,5	400
		1926001250	1/2x50	1/2" M	7,5	13,5	1/2" H	7,5	500
		1926001260	1/2x60	1/2" M	7,5	13,5	1/2" H	7,5	600
		1926001280	1/2x80	1/2" M	7,5	13,5	1/2" H	7,5	800
		19260012100	1/2x100	1/2" M	7,5	13,5	1/2" H	7,5	1000
		19260012120	1/2x120	1/2" M	7,5	13,5	1/2" H	7,5	1200
		19260012150	1/2x150	1/2" M	7,5	13,5	1/2" H	7,5	1500

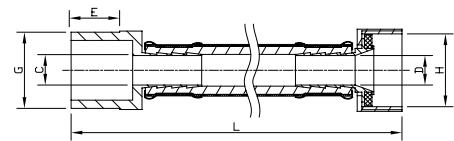

Terminales	Bronce, Mec., Niquelado
Tubo	NBR
Malla	Trenzada de 8 hilos de acero inoxidable AISI 304
Guarnición	PTFE
Presión de trabajo	280 mm C.A.
Observaciones	Terminales Engrampados

FLEXIBLE ACERO INOXIDABLE GAS NATURAL

MODELO	AF GAS-2700	CÓDIGO	MEDIDA	G (mm)	C (mm)	E (mm)	H (mm)	D (mm)	L (mm)
		1927001230	1/2x30	1/2" M	12,5	11,5	1/2" H	12,5	300
		1927001245	1/2x45	1/2" M	12,5	11,5	1/2" H	12,5	450
		1927001260	1/2x60	1/2" M	12,5	11,5	1/2" H	12,5	600
		1927001275	1/2x75	1/2" M	12,5	11,5	1/2" H	12,5	750
		1927001290	1/2x90	1/2" M	12,5	11,5	1/2" H	12,5	900

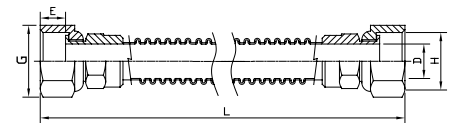

Terminales	Bronce, Mec., Niquelado/ AISI 304
Tubo	AISI 316L
Guarnición	PTFE
Pres. Máx. de trabajo	60 mbar
Observaciones	Terminales soldados

FLEXIBLE EXTENSIBLE GAS NATURAL

MODELO	AF GAS-2800	MEDIDA	G (mm)	C (mm)	E (mm)	H (mm)	D (mm)	L (mm)	
		192800122042	1/2x20/42	1/2" M	12,5	15,5	1/2" H	12,0	200/420
		192800124095	1/2x40/95	1/2" M	12,5	15,5	1/2" H	12,0	400/950
		192800342042	3/4x20/42	3/4" M	18,0	18,0	3/4" H	18,0	200/420
		192800344095	3/4x40/95	3/4" M	18,0	18,0	3/4" H	18,0	400/950

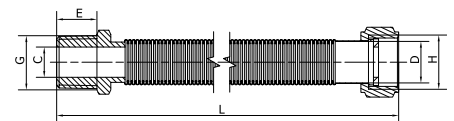

Terminales	Bronce, Mec., Niquelado/ AISI 304
Tubo	AISI 316L
Guarnición	PTFE
Pres. Máx. de trabajo	60 mbar
Observaciones	Terminales soldados

FLEXIBLE EXTENSIBLE PARA MEDIDORES

MODELO	AF GAS-2810	MEDIDA	G (mm)	C (mm)	E (mm)	H (mm)	D (mm)	L (mm)	
		19281011470	1 1/4"	3/4" M	18,0	18,0	1 1/4" H	18,0	300/700
		19281011870	1 1/8"	3/4" M	18,0	18,0	1 1/4" H	18,0	300/700

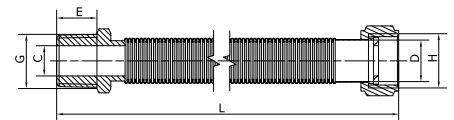

Terminales	Aleación de Aluminio
Tubo	AISI 316L
Pres. Máx. de trabajo	60 mbar
Observaciones	Terminales soldados

FLEXIBLE EXTENSIBLE REVESTIDO GAS NATURAL

MODELO	AF GAS-2900	CÓDIGO	MEDIDA	G (mm)	C (mm)	E (mm)	H (mm)	D (mm)	L (mm)
		192900122042	1/2x20/42	1/2" M	12,5	15,5	1/2" H	12,5	200/420
		192900124095	1/2x40/95	1/2" M	12,5	15,5	1/2" H	12,5	400/950

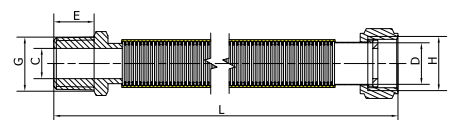

Terminales	Bronce, Mec., Niquelado/ AISI 304
Tubo	AISI 316L, con recubrimiento de polietileno para protección a corrosión severa
Guarnición	PTFE
Pres. Máx. de trabajo	60 mbar
Observaciones	Terminales soldados

AGUA

FLEXIBLE MALLADO DE ACERO INOXIDABLE

MODELO	AF-2075	CÓDIGO	MEDIDA	G (pulg.)	C (mm)	E (mm)	H (pulg.)	D (mm)	L (mm)
		1920751220	1/2x20	1/2" M	7	12	1/2" H	7	200
		1920751225	1/2x25	1/2" M	7	12	1/2" H	7	250
		1920751230	1/2x30	1/2" M	7	12	1/2" H	7	300
		1920751235	1/2x35	1/2" M	7	12	1/2" H	7	350
		1920751240	1/2x40	1/2" M	7	12	1/2" H	7	400
		1920751250	1/2x50	1/2" M	7	12	1/2" H	7	500
		1920753420	3/4x20	3/4" M	9,5	14	3/4" H	10	200
		1920753425	3/4x25	3/4" M	9,5	14	3/4" H	10	250
		1920753430	3/4x30	3/4" M	9,5	14	3/4" H	10	300
		1920753435	3/4x35	3/4" M	9,5	14	3/4" H	10	350
		1920753440	3/4x40	3/4" M	9,5	14	3/4" H	10	400
		1920753450	3/4x50	3/4" M	9,5	14	3/4" H	10	500

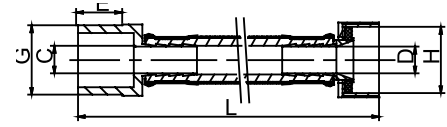

Terminales	Bronce, Mec., Niquelado
Conexiones	BSP
Tubo	EPDM Atóxico
Malla	Trenzada de 8 hilos de acero inoxidable
Guarnición	NBR
Observaciones	Terminales engrampados



FLEXIBLE MALLADO ACERO INOXIDABLE MACHO GIRATORIO C/ LLAVE DE AJUSTE PLÁSTICA

MODELO	AF-2076	CÓDIGO	MEDIDA	G (pulg.)	C (mm)	E (mm)	H (pulg.)	D (mm)	L (mm)
		1920761220	1/2x20	1/2" M	7	13,5	1/2" H	7	200
		1920761225	1/2x25	1/2" M	7	13,5	1/2" H	7	250
		1920761230	1/2x30	1/2" M	7	13,5	1/2" H	7	300
		1920761235	1/2x35	1/2" M	7	13,5	1/2" H	7	350
		1920761240	1/2x40	1/2" M	7	13,5	1/2" H	7	400
		1920761250	1/2x50	1/2" M	7	13,5	1/2" H	7	500
		1920763420	3/4x20	3/4" M	12	14	3/4" H	10	200
		1920763425	3/4x25	3/4" M	12	14	3/4" H	10	250
		1920763430	3/4x30	3/4" M	12	14	3/4" H	10	300
		1920763435	3/4x35	3/4" M	12	14	3/4" H	10	350
		1920763440	3/4x40	3/4" M	12	14	3/4" H	10	400
		1920763450	3/4x50	3/4" M	12	14	3/4" H	10	500



MACHO GIRATORIO

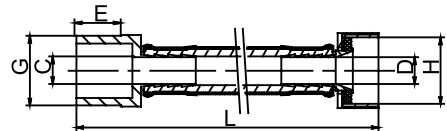

Terminales	Bronce, Mec., Niquelado
Conexiones	BSP
Tubo	EPDM Atóxico
Malla	Trenzada de 8 hilos de acero inoxidable
Guarnición	NBR
Observaciones	Terminales engrampados

FLEXIBLE MALLADO

MODELO	AF-2078	CÓDIGO	MEDIDA	G (pulg.)	C (mm)	E (mm)	H (pulg.)	D (mm)	L (mm)
		1920781220	1/2x20	1/2" M	7	11,5	1/2" H	7,0	200
		1920781225	1/2x25	1/2" M	7	11,5	1/2" H	7,0	250
		1920781230	1/2x30	1/2" M	7	11,5	1/2" H	7,0	300
		1920781235	1/2x35	1/2" M	7	11,5	1/2" H	7,0	350
		1920781240	1/2x40	1/2" M	7	11,5	1/2" H	7,0	400
		1920781250	1/2x50	1/2" M	7	11,5	1/2" H	7,0	500
		1920783420	3/4x20	3/4" M	9,5	13,0	3/4" H	10,2	200
		1920783425	3/4x25	3/4" M	9,5	13,0	3/4" H	10,2	250
		1920783430	3/4x30	3/4" M	9,5	13,0	3/4" H	10,2	300
		1920783435	3/4x35	3/4" M	9,5	13,0	3/4" H	10,2	350
		1920783440	3/4x40	3/4" M	9,5	13,0	3/4" H	10,2	400
		1920783450	3/4x50	3/4" M	9,5	13,0	3/4" H	10,2	500

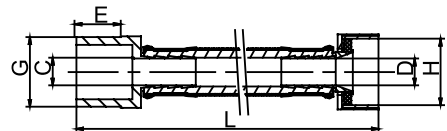

Terminales	Bronce, Mecanizado, Niquelado
Tubo	EPDM Atóxico
Malla	Trenzada de 8 hilos de aluminio
Guarnición	NBR
Observaciones	Terminales Engrampados

FLEXIBLE MALLADO ACERO INOX. P/BOMBA

MODELO	AF-2074	CÓDIGO	MEDIDA	G (pulg.)	C (mm)	E (mm)	H (pulg.)	D (mm)	L (mm)
		1920740150	1x50	1" M	19,8	11,1	1" H	19,8	500

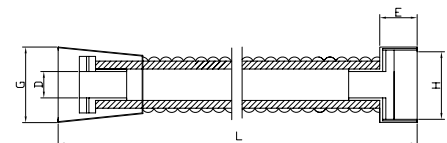

Terminales	Bronce, Mecanizado, Niquelado
Conexiones	BSP
Tubo	EPDM Atóxico
Malla	Trenzada de acero inoxidable
Guarnición	NBR
Observaciones	Terminales engrampados

FLEXIBLE P/MONOCOMANDO POR 2 UN.

MODELO	AF-2071	CÓDIGO	MEDIDA	G (mm)	C (mm)	E (mm)	H (mm)	L (mm)
		505270150	1/2x40	1/2" H	39	17	M 10*1	400

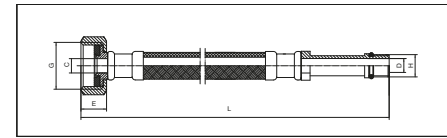

Terminales	Bronce, Mec., Niquelado
Conexiones	BSP
Tubo	EPDM Atóxico
Malla	Trenzada de acero inoxidable
Guarnición	NBR
Observaciones	Terminales engrampados

FLEXIBLE P/MONOCOMANDO MACHO GIRATORIO POR 2 UN.

MODELO	AF-2072	CÓDIGO	MEDIDA	G (pulg.)	C (mm)	E (mm)	H (pulg.)	L (mm)
		1920721040	1/2x40	1/2" M	39	17	M 10*1	400

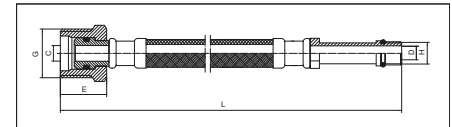

Terminales	Bronce, Mec., Niquelado
Conexiones	BSP
Tubo	EPDM Atóxico
Malla	Trenzada de acero inoxidable
Guarnición	NBR
Observaciones	Terminales engrampados

FLEXIBLE DE COBRE ANILLADO CROMADO

MODELO	AF-2080	CÓDIGO	MEDIDA	G (pulg.)	C (mm)	E (mm)	H (pulg.)	D (mm)	L (mm)
		19208012201	1/2x20	1/2" M	14	13	1/2" H	13,5	200
		19208012251	1/2x25	1/2" M	14	13	1/2" H	13,5	250
		19208012301	1/2x30	1/2" M	14	13	1/2" H	13,5	300
		19208012351	1/2x35	1/2" M	14	13	1/2" H	13,5	350
		19208012401	1/2x40	1/2" M	14	13	1/2" H	13,5	400
		19208012501	1/2x50	1/2" M	14	13	1/2" H	13,5	500
		19208034201	3/4x20	3/4" M	18	13	3/4" H	18	200
		19208034251	3/4x25	3/4" M	18	13	3/4" H	18	250
		19208034301	3/4x30	3/4" M	18	13	3/4" H	18	300
		19208034351	3/4x35	3/4" M	18	13	3/4" H	18	350
		19208034401	3/4x40	3/4" M	18	13	3/4" H	18	400
		19208034501	3/4x50	3/4" M	18	13	3/4" H	18	500

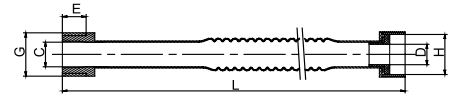

Terminales	Bronce, Mec., Niquelado
Conexiones	BSP
Tubo	Cobre de Alta Dureza, Anillado
Guarnición	NBR
Observaciones	Terminales soldados, Hembra móvil

FLEXIBLE ANILLADO DE ACERO INOXIDABLE

MODELO	AF-2084	CÓDIGO	MEDIDA	G (pulg.)	C (mm)	E (mm)	H (pulg.)	D (mm)	L (mm)
		1920841220	1/2x20	1/2" M	14,5	10	1/2" H	14,5	200
		1920841225	1/2x25	1/2" M	14,5	10	1/2" H	14,5	250
		1920841230	1/2x30	1/2" M	14,5	10	1/2" H	14,5	300
		1920841235	1/2x35	1/2" M	14,5	10	1/2" H	14,5	350
		1920841240	1/2x40	1/2" M	14,5	10	1/2" H	14,5	400
		1920841250	1/2x50	1/2" M	14,5	10	1/2" H	14,5	500
		1920843420	3/4x20	3/4" M	18,5	13	3/4" H	18,5	200
		1920843425	3/4x25	3/4" M	18,5	13	3/4" H	18,5	250
		1920843430	3/4x30	3/4" M	18,5	13	3/4" H	18,5	300
		1920843435	3/4x35	3/4" M	18,5	13	3/4" H	18,5	350
		1920843440	3/4x40	3/4" M	18,5	13	3/4" H	18,5	400
		1920843450	3/4x50	3/4" M	18,5	13	3/4" H	18,5	500

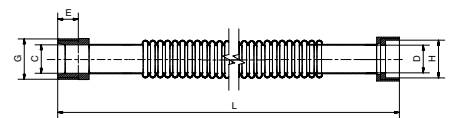

Terminales	Bronce, Mecanizado.
Conexiones	BSP
Tubo	Acero Inoxidable, Anillado.
Guarnición	NBR
Terminación	Recocido, Pulido
Observaciones	Terminales soldados, hembra móvil

FLEXIBLE ANILLADO DE ACERO INOXIDABLE MACHO GIRATORIO

MODELO	AF-2085	CÓDIGO	MEDIDA	G (pulg.)	C (mm)	E (mm)	H (pulg.)	D (mm)	L (mm)
		1920851220	1/2x20	1/2" M	14,5	10	1/2" H	14	200
		1920851225	1/2x25	1/2" M	14,5	10	1/2" H	14	250
		1920851230	1/2x30	1/2" M	14,5	10	1/2" H	14	300
		1920851235	1/2x35	1/2" M	14,5	10	1/2" H	14	350
		1920851240	1/2x40	1/2" M	14,5	10	1/2" H	14	400
		1920851250	1/2x50	1/2" M	14,5	10	1/2" H	14	500
		1920853420	3/4x20	3/4" M	18,5	13	3/4" H	18	200
		1920853425	3/4x25	3/4" M	18,5	13	3/4" H	18	250
		1920853430	3/4x30	3/4" M	18,5	13	3/4" H	18	300
		1920853435	3/4x35	3/4" M	18,5	13	3/4" H	18	350
		1920853440	3/4x40	3/4" M	18,5	13	3/4" H	18	400
		1920853450	3/4x50	3/4" M	18,5	13	3/4" H	18	500

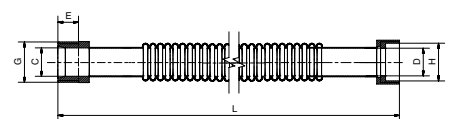

Terminales	Bronce, Mecanizado.
Conexiones	BSP
Tubo	Acero Inoxidable, Anillado.
Guarnición	NBR
Terminación	Recocido, Pulido, Cromado.
Observaciones	Terminales Macho y Hembra móvil

■ GAS ■ AGUA

FLEXIBLE DE PVC

MODELO	AF-2095	CÓDIGO	MEDIDA	G (pulg.)	C (mm)	E (mm)	H (pulg.)	D (mm)	L (mm)
		1920951230	1/2x30	1/2" M	7,0	13	1/2" H	7	300
		1920951240	1/2x40	1/2" M	7,0	13	1/2" H	7	400
		1920951250	1/2x50	1/2" M	7,0	13	1/2" H	7	500

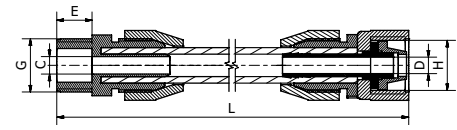

Terminales	Plásticos
Tubo	PVC
Observaciones	PVC color gris

FLEXIBLE PARA DUCHADOR

MODELO	AF-270	CÓDIGO	MEDIDA	G (mm)	D (mm)	E (mm)	H (mm)	L (mm)
		505270150	1/2x1.50	1/2"H	7,00	11,50	1/2"H	1,50
		505270180	1/2x1.80	1/2"H	7,00	11,50	1/2"H	1,80
		505270200	1/2x2.00	1/2"H	7,00	11,50	1/2"H	2,00

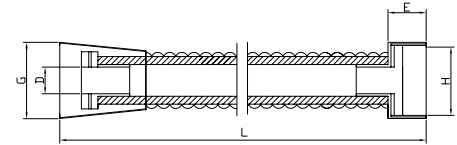

Terminales	ABS Cromado
Tubo	EPDM Atóxico
Malla	Acero inoxidable AISI 304
Guarnición	Silicona

ROSETA METALICA PARA FLEXIBLE MALLADO

MODELO	AF-2270	CÓDIGO	MEDIDA	Di	De
		19227012	1/2"	Øx	Øx



DESCARGAS Y SIFONES

DESCARGA FLEXIBLE PARA LAVATORIO CON ADAPTADOR

MODELO	AF-2100	CÓDIGO	MEDIDA	L (mm)	A* (mm)	B* (mm)
		19210011440	1/4x40	500	110	210



A: mínima 35mm / máxima 110mm.
B: mínima 70mm / máxima 210mm.

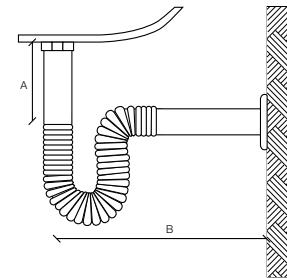

SIFÓN FLEXIBLE PARA LAVATORIO CON ADAPTADOR

MODELO	AF-2900	CÓDIGO	MEDIDA	L (mm)	A* (mm)	B (mm)
		362900	1 1/4-40	500	85/160	390



(*) A: mínima 85mm / máxima 160mm.

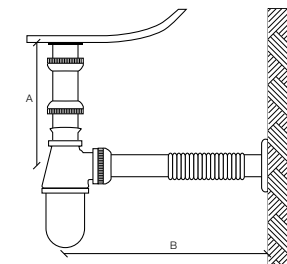

SIFÓN RÍGIDO PARA LAVATORIO CON ADAPTADOR

MODELO	AF-2950	CÓDIGO	MEDIDA	L (mm)	A* (mm)	B (mm)
		362800	1 1/4-40	500	85/160	390



(*) A: mínima 85mm / máxima 160mm.

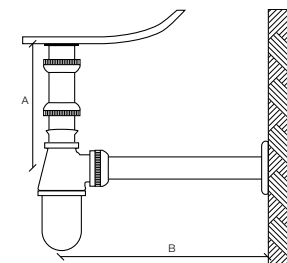

SIFÓN CUADRADO PREMIUM

MODELO	AF-2955	CÓDIGO	MEDIDA	L (mm)	A*(mm) min/máx	B*(mm) min/máx
		362955	1 1/4	500	110	350



A: máxima 110mm.
B: máxima 350mm.

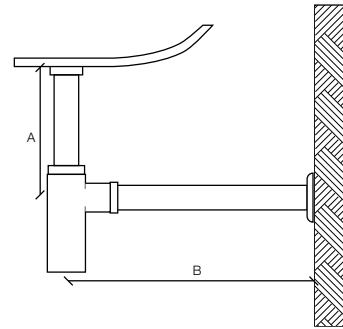

SIFÓN CILÍNDRICO PREMIUM

MODELO	AF-2956	CÓDIGO	MEDIDA	L (mm)	A*(mm) min/máx	B*(mm) min/máx
		362956	1 1/4-40	500	110	350



A: máxima 110mm.
B: máxima 350mm.

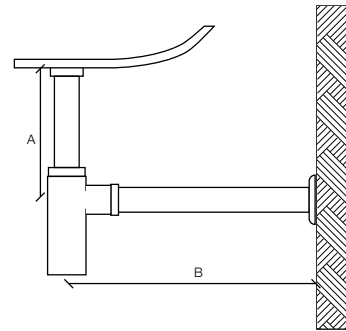

Sifones para
instalaciones a la vista

SIFÓN CUADRADO PREMIUM AF-2955

SIFÓN CILÍNDRICO PREMIUM AF-2956

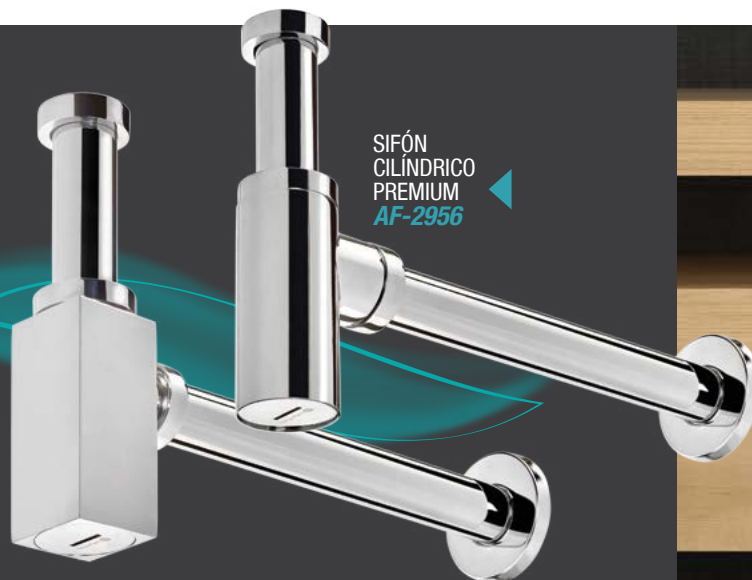

+estéticos
+robustos



DESCARGA RÍGIDA PARA LAVATORIO CON ADAPTADOR

MODELO	AF-2150	CÓDIGO	MEDIDA	A (mm)	B (mm)	C (mm)
		1921502530	25 x 30	25	30	32
		1921504040	40 x 40	40	40	32

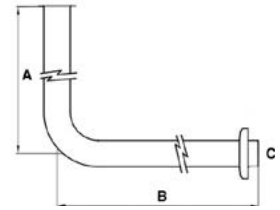

Cuerpo	Tubo Acero Inoxidable
Sellos	NBR
Conexión caños	PVC
Terminación	Cromado, Pulido

CONEXIÓN FLEXIBLE PARA INODORO CON ADAPTADOR

MODELO	AF-2200	CÓDIGO	MEDIDA	L (mm)	A (mm)	B (mm)	C (mm)	G (mm)
		192200	1 1/4-40mm	200	73	80	32	40

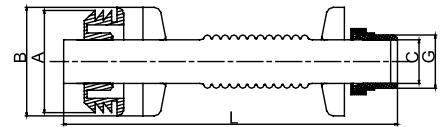

Cuerpo	Tubo de Cobre de Alta Pureza y recocado
Sellos	NBR
Conexión caños	PVC
Terminación	Cromado, Pulido

CONEXIÓN RÍGIDA PARA INODORO CON ADAPTADOR

MODELO	AF-2300	CÓDIGO	MEDIDA	L (mm)	A (mm)	B (mm)	C (mm)
		192300	1 1/4-40mm	200	73	80	38

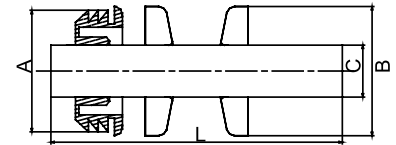

Cuerpo	Tubo de Cobre de alta pureza y recocado
Sellos	NBR
Conexión caños	PVC
Terminación	Cromado, Pulido

ENTRADA PARA MINGITORIO CON ADAPTADOR

MODELO	AF-2400	CÓDIGO	MEDIDA (PULG./MM)	L (mm)	A (mm)	B (mm)	C (mm)	G (mm)
		192400	1/2x300mm	300	43	60	15	1/2

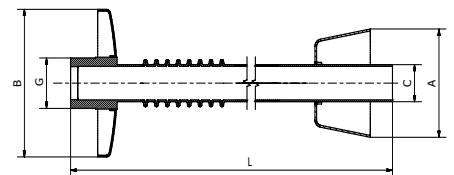

Cuerpo	Tubo de Cobre de Alta Pureza y recocado
Sellos	NBR
Conexión caños	PVC
Terminación	Cromado, Pulido

DESCARGA PARA MINGITORIO CON ADAPTADOR

MODELO	AF-2500	CÓDIGO	MEDIDA	L (mm)	A (mm)	B (mm)	C (mm)	G (mm)
		192500	1 1/4-320mm	320	60	80	32	40

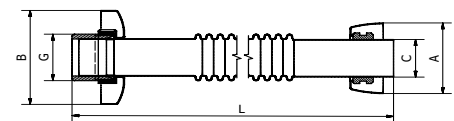

Cuerpo	Tubo de Cobre de Alta Pureza y recocado
Sellos	NBR
Conexión caños	PVC
Terminación	Cromado, Pulido