

# CATÁLOGO DE PRODUCTOS



LATYN·CNIX



# índice

<b>LATYNFLEX</b>	<b>.5</b>
Conexiones flexibles	
<b>VALFORTE</b>	<b>.13</b>
Broncería sanitaria	
<b>LATYN</b>	<b>.23</b>
Galvanizado / Epoxi	
<b>LATYNPLAST</b>	<b>.27</b>
Conexiones termoplásticas	
<b>LATYNBIO</b>	<b>.31</b>
Estética inteligente	
<b>PLUVIUS</b>	<b>.35</b>
Sistemas de bombeo	
<b>LATYN-FUSIÓN</b>	<b>.41</b>
Sistema termofusión de conducción de agua	

# LATYN·CNX

## ESPECIALISTAS EN SOLUCIONES

**LATYN CNX** es la unidad de negocio de Grupo Latyn que reúne las marcas más reconocidas del mercado para instalaciones y conexiones sanitarias, con un portfolio diseñado para dar respuesta a cada necesidad de forma integral.

Con una de las propuestas más amplias del sector, aseguramos abastecimiento eficiente y soluciones completas para cada proyecto, con respaldo y continuidad en cada entrega.

Detrás de cada operación hay un equipo que trabaja de manera articulada, Administración y Ventas, Producto, laboratorio de pruebas y control de calidad, Servicio Técnico y Postventa para garantizar calidad, eficiencia y un servicio confiable.

Somos un equipo que entiende cada sistema, optimiza cada decisión y potencia cada instalación.

**Somos LATYN CNX. Especialistas en soluciones.**



FLEXIBILIDAD  
EN AGUA Y GAS





**Latynflex**  
CONEXIONES FLEXIBLES

■ GAS

■ AGUA

## CONEXIONES FLEXIBLES PARA GAS

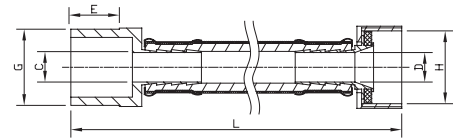

### FLEXIBLE MALLADO ACERO INOXIDABLE - GAS LICUADO

MODELO	AF GAS-2600	CÓDIGO	MEDIDA	G (mm)	C (mm)	E (mm)	H (mm)	D (mm)	L (mm)
 	1926001230	1/2x30	1/2" M	7,5	13,5	1/2" H	7,5	300	
	1926001240	1/2x40	1/2" M	7,5	13,5	1/2" H	7,5	400	
	1926001250	1/2x50	1/2" M	7,5	13,5	1/2" H	7,5	500	
	1926001260	1/2x60	1/2" M	7,5	13,5	1/2" H	7,5	600	
	1926001280	1/2x80	1/2" M	7,5	13,5	1/2" H	7,5	800	
	19260012100	1/2x100	1/2" M	7,5	13,5	1/2" H	7,5	1000	
	19260012120	1/2x120	1/2" M	7,5	13,5	1/2" H	7,5	1200	
	19260012150	1/2x150	1/2" M	7,5	13,5	1/2" H	7,5	1500	



Terminales	Bronce, Mec., Niquelado
Tubo	NBR
Malla	Trenzada de 8 hilos de acero inoxidable AISI 304
Guarnición	PTFE
Presión de trabajo	280 mm C.A.
Observaciones	Terminales Engrampados

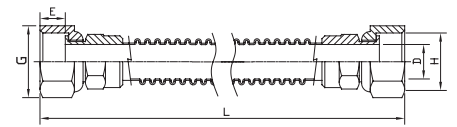

### FLEXIBLE ACERO INOXIDABLE GAS NATURAL

MODELO	AF GAS-2700	CÓDIGO	MEDIDA	G (mm)	C (mm)	E (mm)	H (mm)	D (mm)	L (mm)
 	1927001230	1/2x30	1/2" M	12,5	11,5	1/2" H	12,5	300	
	1927001245	1/2x45	1/2" M	12,5	11,5	1/2" H	12,5	450	
	1927001260	1/2x60	1/2" M	12,5	11,5	1/2" H	12,5	600	
	1927001275	1/2x75	1/2" M	12,5	11,5	1/2" H	12,5	750	
	1927001290	1/2x90	1/2" M	12,5	11,5	1/2" H	12,5	900	



Terminales	Bronce, Mec., Niquelado/ AISI 304
Tubo	AISI 316L
Guarnición	PTFE
Pres. Máx. de trabajo	60 mbar
Observaciones	Terminales soldados

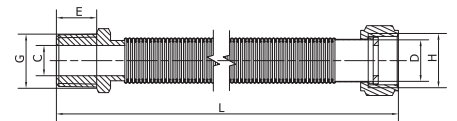

### FLEXIBLE EXTENSIBLE GAS NATURAL

MODELO	AF GAS-2800	MEDIDA	G (mm)	C (mm)	E (mm)	H (mm)	D (mm)	L (mm)
 	192800122042	1/2x20/42	1/2" M	12,5	15,5	1/2" H	12,0	200/420
	192800124095	1/2x40/95	1/2" M	12,5	15,5	1/2" H	12,0	400/950
	192800342042	3/4x20/42	3/4" M	18,0	18,0	3/4" H	18,0	200/420
	192800344095	3/4x40/95	3/4" M	18,0	18,0	3/4" H	18,0	400/950



Terminales	Bronce, Mec., Niquelado/ AISI 304
Tubo	AISI 316L
Guarnición	PTFE
Pres. Máx. de trabajo	60 mbar
Observaciones	Terminales soldados

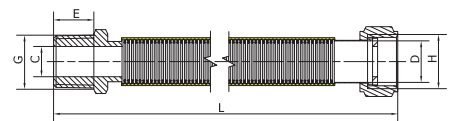

### FLEXIBLE EXTENSIBLE REVESTIDO GAS NATURAL

MODELO	AF GAS-2900	CÓDIGO	MEDIDA	G (mm)	C (mm)	E (mm)	H (mm)	D (mm)	L (mm)
 	192900122042	1/2x20/42	1/2" M	12,5	15,5	1/2" H	12,5	200/420	
	192900124095	1/2x40/95	1/2" M	12,5	15,5	1/2" H	12,5	400/950	



Terminales	Bronce, Mec., Niquelado/ AISI 304
Tubo	AISI 316L, con recubrimiento de polietileno para protección a corrosión severa
Guarnición	PTFE
Pres. Máx. de trabajo	60 mbar
Observaciones	Terminales soldados

### FLEXIBLE EXTENSIBLE PARA MEDIDORES

MODELO	AF GAS-2810	MEDIDA	G (mm)	C (mm)	E (mm)	H (mm)	D (mm)	L (mm)
 	19281011470	1 1/4"	3/4" M	18,0	18,0	1 1/4" H	18,0	300/700
	19281011870	1 1/8"	3/4" M	18,0	18,0	1 1/4" H	18,0	300/700

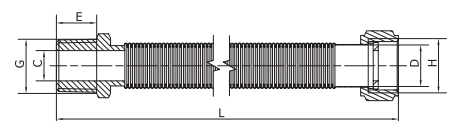

Terminales	Aleación de Aluminio
Tubo	AISI 316L
Pres. Máx. de trabajo	60 mbar
Observaciones	Terminales soldados

**FLEXIBLE EXTENSIBLE P/ TERMOTANQUE**

MODELO	AF GAS-2820	CÓDIGO	MEDIDA	G (mm)	C (mm)	E (mm)	H (mm)	D (mm)	L (mm)
		19282040105	1/2x3/8X1/4	1/2" M	12,2	15,5	3/8" H	8,2	400/1050

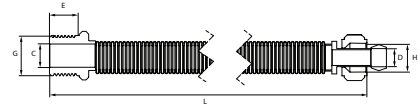

Terminales	Bronce, Mec., Niquelado / AISI 304. Conexión macho 1/2", cierre a virola de 3/8", tuerca giratoria de 3/8"
Tubo	AISI 316L
Guarnición	PTFE
Pres. Máx. de trabajo	60 mbar
Observaciones	Terminales soldados

**FLEXIBLE EXTENSIBLE P/ CALEFACTOR**

MODELO	AF GAS-2830	CÓDIGO	MEDIDA	G (mm)	C (mm)	E (mm)	H (mm)	D (mm)	L (mm)
		1928302030	1/2x5/16X1/4	1/2" M	14	15,5	1/4" H	6,2	200/420
		1928303050	1/2x5/16X1/4	1/2" M	14	15,5	1/4" H	6,2	300/520

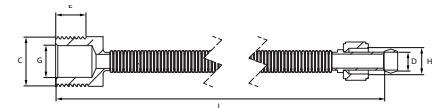

Terminales	Bronce, Mec., Niquelado / AISI 304. Conexión macho 1/2", cierre a virola de 5/16", tuerca giratoria de 1/4"
Tubo	AISI 316L
Guarnición	PTFE
Pres. Máx. de trabajo	60 mbar
Observaciones	Terminales soldados

**CONEXIONES FLEXIBLES PARA AGUA**
**FLEXIBLE MALLADO DE ACERO INOXIDABLE**

MODELO	AF-2075	CÓDIGO	MEDIDA	G (pulg.)	C (mm)	E (mm)	H (pulg.)	D (mm)	L (mm)
		1920751220	1/2x20	1/2" M	7	12	1/2" H	7	200
		1920751225	1/2x25	1/2" M	7	12	1/2" H	7	250
		1920751230	1/2x30	1/2" M	7	12	1/2" H	7	300
		1920751235	1/2x35	1/2" M	7	12	1/2" H	7	350
		1920751240	1/2x40	1/2" M	7	12	1/2" H	7	400
		1920751250	1/2x50	1/2" M	7	12	1/2" H	7	500
		1920753420	3/4x20	3/4" M	9,5	14	3/4" H	10	200
		1920753425	3/4x25	3/4" M	9,5	14	3/4" H	10	250
		1920753430	3/4x30	3/4" M	9,5	14	3/4" H	10	300
		1920753435	3/4x35	3/4" M	9,5	14	3/4" H	10	350
		1920753440	3/4x40	3/4" M	9,5	14	3/4" H	10	400
		1920753450	3/4x50	3/4" M	9,5	14	3/4" H	10	500

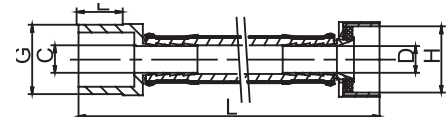

Terminales	Acero Inoxidable AISI 304
Conexiones	BSP
Tubo	EPDM Atóxico
Malla	Trenzada de 8 hilos de acero inoxidable
Guarnición	NBR
Observaciones	Terminales engrapados

**FLEXIBLE MALLADO ACERO INOXIDABLE MACHO GIRATORIO C/ LLAVE DE AJUSTE PLÁSTICA**

MODELO	AF-2076	CÓDIGO	MEDIDA	G (pulg.)	C (mm)	E (mm)	H (pulg.)	D (mm)	L (mm)
		1920761220	1/2x20	1/2" M	7	13,5	1/2" H	7	200
		1920761225	1/2x25	1/2" M	7	13,5	1/2" H	7	250
		1920761230	1/2x30	1/2" M	7	13,5	1/2" H	7	300
		1920761235	1/2x35	1/2" M	7	13,5	1/2" H	7	350
		1920761240	1/2x40	1/2" M	7	13,5	1/2" H	7	400
		1920761250	1/2x50	1/2" M	7	13,5	1/2" H	7	500
		1920763420	3/4x20	3/4" M	12	14	3/4" H	10	200
		1920763425	3/4x25	3/4" M	12	14	3/4" H	10	250
		1920763430	3/4x30	3/4" M	12	14	3/4" H	10	300
		1920763435	3/4x35	3/4" M	12	14	3/4" H	10	350
		1920763440	3/4x40	3/4" M	12	14	3/4" H	10	400
		1920763450	3/4x50	3/4" M	12	14	3/4" H	10	500

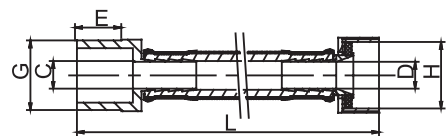
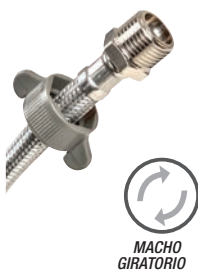

Terminales	Acero Inoxidable AISI 304
Conexiones	BSP
Tubo	EPDM Atóxico
Malla	Trenzada de 8 hilos de acero inoxidable
Guarnición	NBR
Observaciones	Terminales engrapados

## CONEXIONES FLEXIBLES PARA AGUA

### FLEXIBLE MALLADO

MODELO	AF-2078	CÓDIGO	MEDIDA	G (pulg.)	C (mm)	E (mm)	H (pulg.)	D (mm)	L (mm)
		1920781220	1/2x20	1/2" M	7	11,5	1/2" H	7,0	200
		1920781225	1/2x25	1/2" M	7	11,5	1/2" H	7,0	250
		1920781230	1/2x30	1/2" M	7	11,5	1/2" H	7,0	300
		1920781235	1/2x35	1/2" M	7	11,5	1/2" H	7,0	350
		1920781240	1/2x40	1/2" M	7	11,5	1/2" H	7,0	400
		1920781250	1/2x50	1/2" M	7	11,5	1/2" H	7,0	500
		1920783420	3/4x20	3/4" M	9,5	13,0	3/4" H	10,2	200
		1920783425	3/4x25	3/4" M	9,5	13,0	3/4" H	10,2	250
		1920783430	3/4x30	3/4" M	9,5	13,0	3/4" H	10,2	300
		1920783435	3/4x35	3/4" M	9,5	13,0	3/4" H	10,2	350
		1920783440	3/4x40	3/4" M	9,5	13,0	3/4" H	10,2	400
		1920783450	3/4x50	3/4" M	9,5	13,0	3/4" H	10,2	500

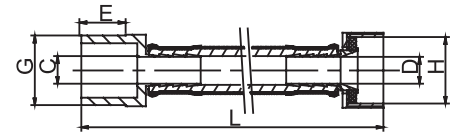

Terminales	Acero Inoxidable AISI 304
Tubo	EPDM Atóxico
Malla	Trenzada de 8 hilos de aluminio
Guarnición	NBR
Observaciones	Terminales Engrampados

### FLEXIBLE MALLADO ACERO INOX. P/BOMBA

MODELO	AF-2074	CÓDIGO	MEDIDA	G (pulg.)	C (mm)	E (mm)	H (pulg.)	D (mm)	L (mm)
		1920740150	1x50	1" M	19,8	11,1	1" H	19,8	500

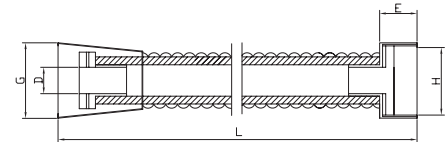

Terminales	Bronce, Mecanizado, Niquelado
Conexiones	BSP
Tubo	EPDM Atóxico
Malla	Trenzada de acero inoxidable
Guarnición	NBR
Observaciones	Terminales engrampados

### FLEXIBLE MALLADO NYLON CON MARIPOSA

MODELO	AF-2079	CÓDIGO	MEDIDA	G (pulg.)	C (mm)	E (mm)	H (pulg.)	D (mm)	L (mm)
		1920791220	1/2x20	1/2" M	14,5	13,5	1/2" H	15	200
		1920791225	1/2x25	1/2" M	14,5	13,5	1/2" H	15	250
		1920791230	1/2x30	1/2" M	14,5	13,5	1/2" H	15	300
		1920791235	1/2x35	1/2" M	14,5	13,5	1/2" H	15	350
		1920791240	1/2x40	1/2" M	14,5	13,5	1/2" H	15	400
		1920791250	1/2x50	1/2" M	14,5	13,5	1/2" H	15	500
		1920793420	3/4x20	3/4" M	18,5	16	3/4" H	18	200
		1920793425	3/4x25	3/4" M	18,5	16	3/4" H	18	250
		1920793430	3/4x30	3/4" M	18,5	16	3/4" H	18	300
		1920793435	3/4x35	3/4" M	18,5	16	3/4" H	18	350
		1920793440	3/4x40	3/4" M	18,5	16	3/4" H	18	400
		1920793450	3/4x50	3/4" M	18,5	16	3/4" H	18	500

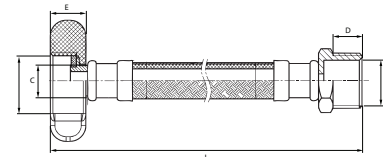

Terminales	Bronce, Mariposa de POM
Conexiones	BSP
Tubo	Trenzada de Nylon
Guarnición	NBR
Terminación	Recocido
Observaciones	Terminales engrampados, mariposa para ajuste manual

### FLEXIBLE ANILLADO DE ACERO INOXIDABLE

MODELO	AF-2084	CÓDIGO	MEDIDA	G (pulg.)	C (mm)	E (mm)	H (pulg.)	D (mm)	L (mm)
		1920841220	1/2x20	1/2" M	14,5	10	1/2" H	14,5	200
		1920841225	1/2x25	1/2" M	14,5	10	1/2" H	14,5	250
		1920841230	1/2x30	1/2" M	14,5	10	1/2" H	14,5	300
		1920841235	1/2x35	1/2" M	14,5	10	1/2" H	14,5	350
		1920841240	1/2x40	1/2" M	14,5	10	1/2" H	14,5	400
		1920841250	1/2x50	1/2" M	14,5	10	1/2" H	14,5	500
		1920843420	3/4x20	3/4" M	18,5	13	3/4" H	18,5	200
		1920843425	3/4x25	3/4" M	18,5	13	3/4" H	18,5	250
		1920843430	3/4x30	3/4" M	18,5	13	3/4" H	18,5	300
		1920843435	3/4x35	3/4" M	18,5	13	3/4" H	18,5	350
		1920843440	3/4x40	3/4" M	18,5	13	3/4" H	18,5	400
		1920843450	3/4x50	3/4" M	18,5	13	3/4" H	18,5	500

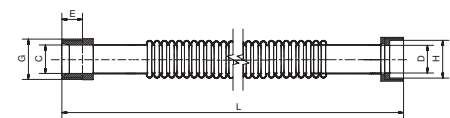

Terminales	Bronce, Mecanizado.
Conexiones	BSP
Tubo	Acero Inoxidable, Anillado.
Guarnición	NBR
Terminación	Recocido, Pullido
Observaciones	Terminales soldados, hembra movil

**FLEXIBLE DE COBRE ANILLADO CROMADO**

MODELO	AF-2080	CÓDIGO	MEDIDA	G (pulg.)	C (mm)	E (mm)	H (pulg.)	D (mm)	L (mm)
		19208012201	1/2x20	1/2" M	14	13	1/2" H	13,5	200
		19208012251	1/2x25	1/2" M	14	13	1/2" H	13,5	250
		19208012301	1/2x30	1/2" M	14	13	1/2" H	13,5	300
		19208012351	1/2x35	1/2" M	14	13	1/2" H	13,5	350
		19208012401	1/2x40	1/2" M	14	13	1/2" H	13,5	400
		19208012501	1/2x50	1/2" M	14	13	1/2" H	13,5	500
		19208034201	3/4x20	3/4" M	18	13	3/4" H	18	200
		19208034251	3/4x25	3/4" M	18	13	3/4" H	18	250
		19208034301	3/4x30	3/4" M	18	13	3/4" H	18	300
		19208034351	3/4x35	3/4" M	18	13	3/4" H	18	350
		19208034401	3/4x40	3/4" M	18	13	3/4" H	18	400
		19208034501	3/4x50	3/4" M	18	13	3/4" H	18	500

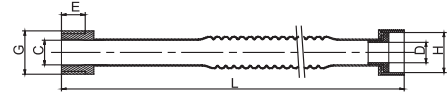

Terminales	Bronce, Mec., Niquelado
Conexiones	BSP
Tubo	Cobre de Alta Dureza, Anillado
Guarnición	NBR
Observaciones	Terminales soldados, Hembra móvil

**FLEXIBLE P/MONOCOMANDO POR 2 UN.**

MODELO	AF-2071	CÓDIGO	MEDIDA	G (mm)	C (mm)	E (mm)	H (mm)	L (mm)
		1920711040	1/2x40	1/2" H	39	17	M 10*1	400
		1920710840	1/2x40	1/2" H	39	17	M 8*1	400
		1920711240	1/2x40	1/2" H	39	17	M 1/2*1	400

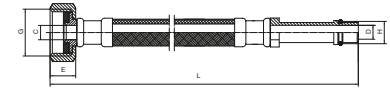

Terminales	Bronce, Mec., Niquelado
Conexiones	BSP
Tubo	EPDM Atóxico
Malla	Trenzada de acero inoxidable
Guarnición	NBR
Observaciones	Terminales engrapados

**FLEXIBLE P/MONOCOMANDO MACHO GIRATORIO POR 2 UN.**

MODELO	AF-2072	CÓDIGO	MEDIDA	G (pulg.)	C (mm)	E (mm)	H (pulg.)	L (mm)
		1920721040	1/2x40	1/2" M	39	17	M 10*1	400

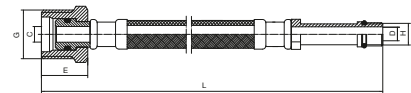

Terminales	Bronce, Mec., Niquelado
Conexiones	BSP
Tubo	EPDM Atóxico
Malla	Trenzada de acero inoxidable
Guarnición	NBR
Observaciones	Terminales engrapados

**FLEXIBLE DE PVC**

MODELO	AF-2095	CÓDIGO	MEDIDA	G (pulg.)	C (mm)	E (mm)	H (pulg.)	D (mm)	L (mm)
		1920951230	1/2x30	1/2" M	7,0	13	1/2" H	7	300
		1920951240	1/2x40	1/2" M	7,0	13	1/2" H	7	400
		1920951250	1/2x50	1/2" M	7,0	13	1/2" H	7	500

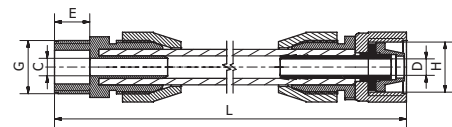

Terminales	Plásticos
Tubo	PVC
Observaciones	PVC color blanco

**ROSETA METÁLICA PARA FLEXIBLE MALLADO**

MODELO	AF-2270	CÓDIGO	MEDIDA
		19227012	1/2"
		17227034	3/4"



■ GAS

■ AGUA

DESCARGAS Y SIFONES

DESCARGA FLEXIBLE PARA LAVATORIO CON ADAPTADOR

MODELO	AF-2100	CÓDIGO	MEDIDA	L (mm)	A* (mm)	B* (mm)
		19210011440	1/4x40	500	110	210



A: mínima 35mm / máxima 110mm.  
B: mínima 70mm / máxima 210mm.

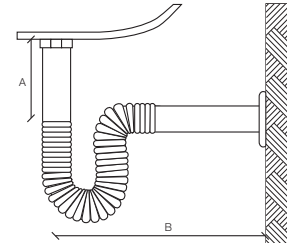

SIFÓN FLEXIBLE PARA LAVATORIO CON ADAPTADOR

MODELO	AF-2900	CÓDIGO	MEDIDA	L (mm)	A* (mm)	B (mm)
		362900	1 1/4-40	500	85/160	390



(\*) A: mínima 85mm / máxima 160mm.

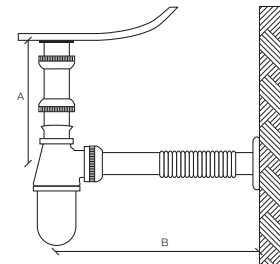

SIFÓN RÍGIDO PARA LAVATORIO CON ADAPTADOR

MODELO	AF-2950	CÓDIGO	MEDIDA	L (mm)	A* (mm)	B (mm)
		362800	1 1/4-40	500	85/160	390



(\*) A: mínima 85mm / máxima 160mm.

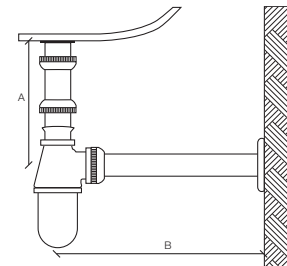

SIFÓN CUADRADO PREMIUM

MODELO	AF-2955	CÓDIGO	MEDIDA	L (mm)	A* (mm)	B* (mm)
		362955	1 1/4	500	110	350



A: máxima 110mm.  
B: máxima 350mm.

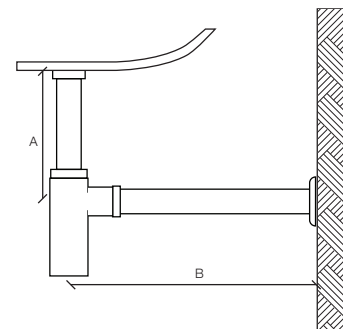

SIFÓN CILÍNDRICO PREMIUM

MODELO	AF-2956	CÓDIGO	MEDIDA	L (mm)	A* (mm)	B* (mm)
		362956	1 1/4-40	500	110	350



A: máxima 110mm.  
B: máxima 350mm.

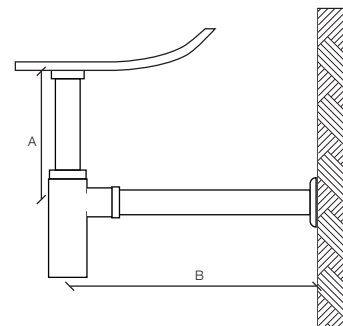



## Todas las soluciones para agua y gas

FLEXIBLES EXTENSIBLES DE 15 A 30 CM



Acero  
Inoxidable



Conexión  
extensible  
15 a 30 cm



Fácil de  
instalar



Flexible

**+seguros**  
**+estéticos**

MATRÍCULA  
N° 1583-43



Instituto del  
Gas Argentino



GAS

AGUA

## DESCARGA RÍGIDA PARA LAVATORIO CON ADAPTADOR

MODELO	AF- 2150	CÓDIGO	MEDIDA	A (mm)	B (mm)	C (mm)
		1921502530	25 x 30	25	30	32
		1921504040	40 x 40	40	40	32

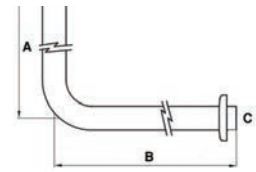

Cuerpo	Tubo Acero Inoxidable
Sellos	NBR
Conexión caños	PVC
Terminación	Cromado, Pulido

## CONEXIÓN FLEXIBLE PARA INODORO CON ADAPTADOR

MODELO	AF-2200	CÓDIGO	MEDIDA	L (mm)	A (mm)	B (mm)	C (mm)	G (mm)
		192200	1 1/4-40mm	200	73	80	32	40

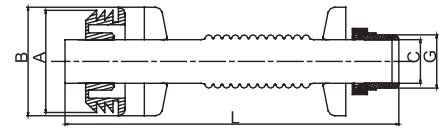

Cuerpo	Tubo de Cobre de Alta Pureza y recocado
Sellos	NBR
Conexión caños	PVC
Terminación	Cromado, Pulido

## CONEXIÓN RÍGIDA PARA INODORO CON ADAPTADOR

MODELO	AF-2300	CÓDIGO	MEDIDA	L (mm)	A (mm)	B (mm)	C (mm)
		192300	1 1/4-40mm	200	73	80	38

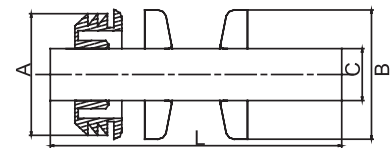

Cuerpo	Tubo de Cobre de alta pureza y recocado
Sellos	NBR
Conexión caños	PVC
Terminación	Cromado, Pulido

## ENTRADA PARA MINGITORIO CON ADAPTADOR

MODELO	AF-2400	CÓDIGO	MEDIDA (PUL. x mm)	L (mm)	A (mm)	B (mm)	C (mm)	G (mm)
		192400	1/2x300mm	300	43	60	15	1/2

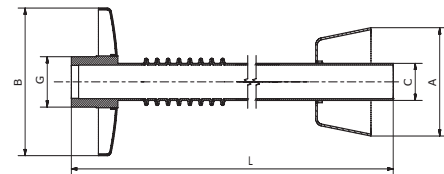

Cuerpo	Tubo de Cobre de Alta Pureza y recocado
Sellos	NBR
Conexión caños	PVC
Terminación	Cromado, Pulido

## DESCARGA PARA MINGITORIO CON ADAPTADOR

MODELO	AF-2500	CÓDIGO	MEDIDA	L (mm)	A (mm)	B (mm)	C (mm)	G (mm)
		192500	1 1/4-320mm	320	60	80	32	40

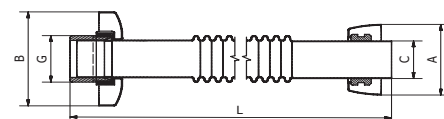

Cuerpo	Tubo de Cobre de Alta Pureza y recocado
Sellos	NBR
Conexión caños	PVC
Terminación	Cromado, Pulido

**CIERRE SEGURO,  
GARANTÍA TOTAL**

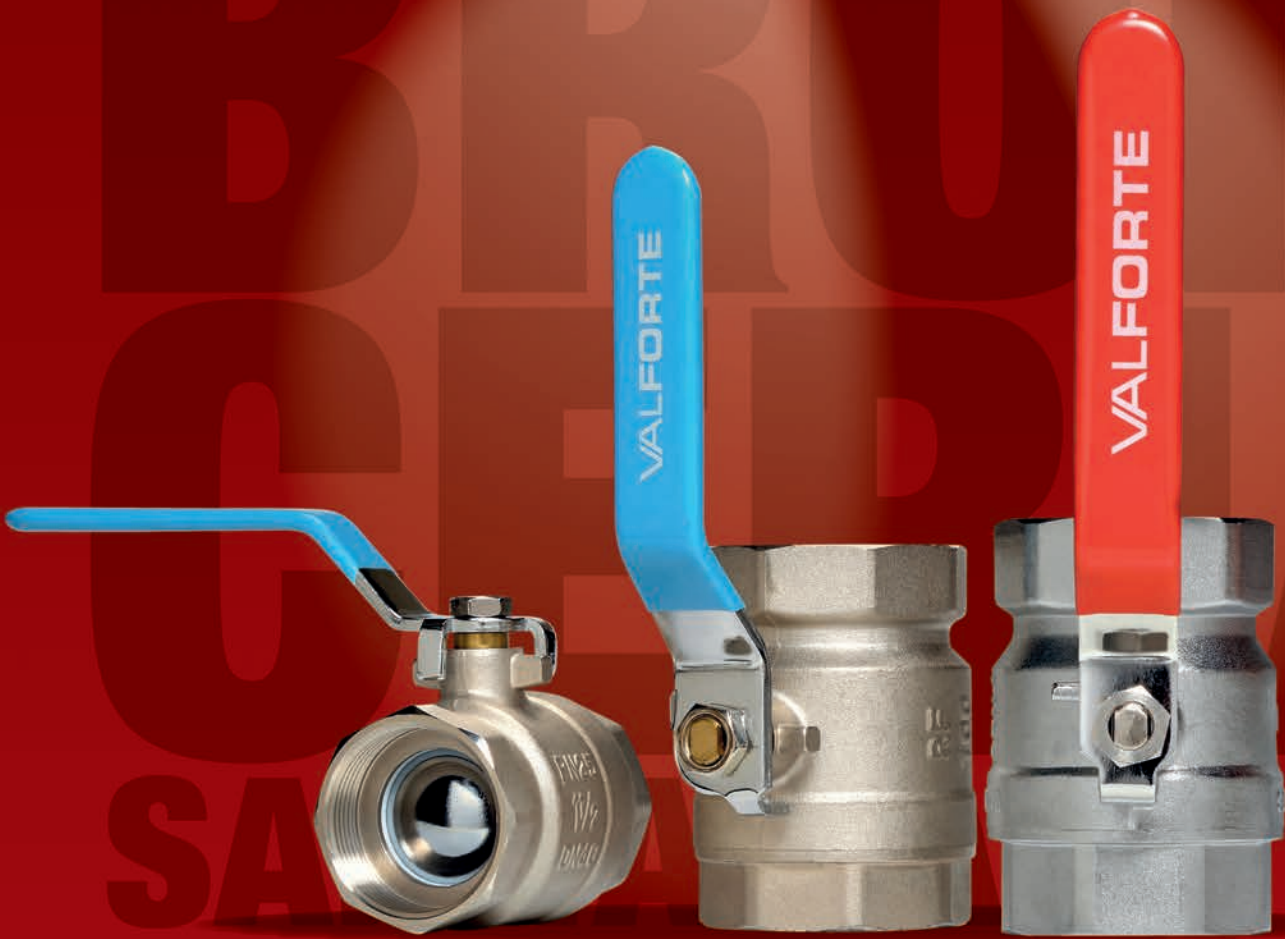

**VALFORTE**  
BRONCERÍA SANITARIA

GAS

AGUA

VÁLVULAS PARA GAS

VÁLVULA ESFÉRICA 4 BAR PASO TOTAL

MODELO	RF-GAS 700	CÓDIGO	MEDIDA	A (mm)	B (mm)	C (mm)	L (mm)	G (mm)	E (mm)
		1370034	3/4"	118	50	19	65	18	18



Aprobadas por  
Instituto del  
Gas Argentino



Cuerpo, bonete, vástago y tapa de sello de bronce. Sellos y asientos PTFE. Esferas de bronce cromado. Protectores roscas plásticos.

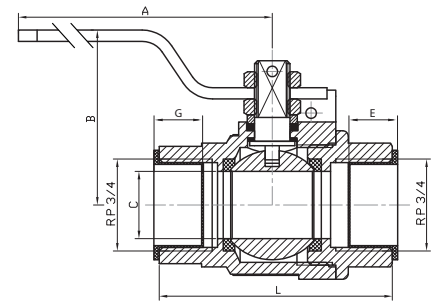

VÁLVULA ESFÉRICA 4 BAR

MODELO	RF-GAS 800	CÓDIGO	MEDIDA	A (mm)	B (mm)	C (mm)	L (mm)	G (mm)	E (mm)
		1370134	3/4"	87	50	15	65	18	18



Aprobadas por  
Instituto del  
Gas Argentino



Cuerpo, bonete, vástago y tapa de sello de bronce. Sellos y asientos PTFE. Esferas de bronce cromado. Protectores roscas plásticos.

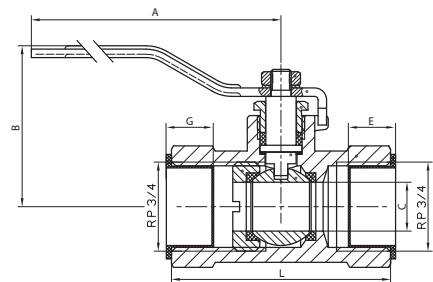

VALFORTE

14

VÁLVULAS PARA AGUA

VÁLVULA ESFÉRICA H-H PLUS

MODELO	RF-PLUS	CÓDIGO	MEDIDA	A (mm)	B (mm)	C (mm)	D (mm)	G (pulg.)	L (mm)
		13114	1/4"	78	37,5	10	10	1/4"	38
		13138	3/8"	74	42,5	10	10	3/8"	44,5
		13112	1/2"	85	47,5	14	11	1/2"	46,5
		13134	3/4"	90	50,5	19	12	3/4"	56
		1311	1"	110	54	24	14,5	1"	65
		131114	1 1/4"	128	69,5	30	14,5	1 1/4"	71
		131112	1 1/2"	138	76,5	37	16,5	1 1/2"	80
		1312	2"	165	85	43	21	2"	102
		131212	2 1/2"	180	110	52	23	2 1/2"	116
		1313	3"	230	114	69	28	3"	149
		1314	4"	230	140	100	32	4"	192
		1316	6"	280	170	135	36,5	6"	255



Cuerpo, bonete y bola de bronce. Asiento de bola de P.T.F.E. Vástago y tuerca de fijación de bronce. Manija de acero cromada, cubierta de PVC. Tuerca de bronce.

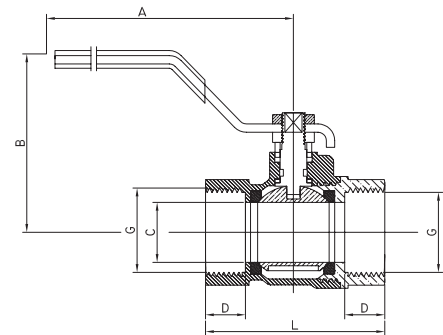

VÁLVULA ESFÉRICA H-H

MODELO	RF-100	CÓDIGO	MEDIDA	A (mm)	B (mm)	C (mm)	D (mm)	G (pulg.)	L (mm)
		1310012	1/2"	85,2	40	14	11	1/2"	46,5
		1310034	3/4"	85,2	46,1	18	12	3/4"	56
		131001	1"	111	57,2	24	14,5	1"	65
		13100114	1 1/4"	141	63	27	14,5	1 1/4"	71
		13100112	1 1/2"	150	76	74	16,5	1 1/2"	86
		131002	2"	195	81,5	43	17	2"	102
		13100212	2 1/2"	230	105	58	23	2 1/2"	121
		131003	3"	230	115	70	28	3"	134,5
		131004	4"	230	133	90	32	4"	192



Cuerpo, bonete y bola de acero cromada. Asiento de bola de P.T.F.E. Manija de acero pintada. Tuerca de acero cromado.

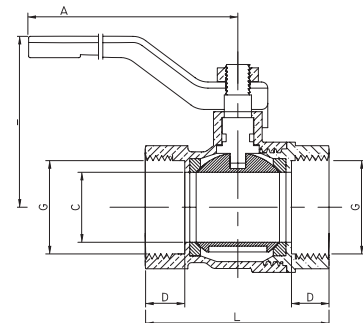

### VÁLVULA ESFÉRICA PASO TOTAL H-H P/RIEGO

MODELO	VW-PLUS	CÓDIGO	MEDIDA	A (mm)	B (mm)	C (mm)	D (mm)	G (pulg.)	L (mm)
		1310212000	1/2"	79,4	40,2	13,3	11,4	1/2"	48,9
		1310234000	3/4"	90,4	46,6	17,4	11,8	3/4"	53,6
		131021000	1"	102	54,6	21,1	13,1	1"	61,2



Cuerpo y bonete: zinc, bola de acero. Asiento de bola de P.T.F.E. Vástago de acero cromado. Cubierta de PVC

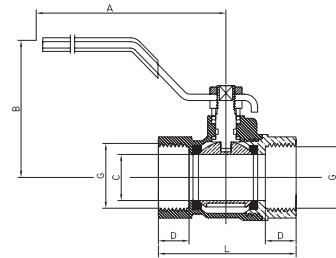

### VÁLVULA ESFÉRICA PASO TOTAL H-H MARIPOSA

MODELO	RF-100B H-H	CÓDIGO	MEDIDA	B (mm)	C (mm)	D (mm)	G (pulg.)	L (mm)
		13210012	1/2"	38	13	11.5	1/2"	46.5
		13210034	3/4"	40	18	11.5	3/4"	55
		1321001	1"	51	23	12.2	1"	60



Cuerpo, bonete y bola de bronce. Asiento de bola de P.T.F.E. Vástago, arandela y tuerca de fijación de bronce. Manija de aluminio.

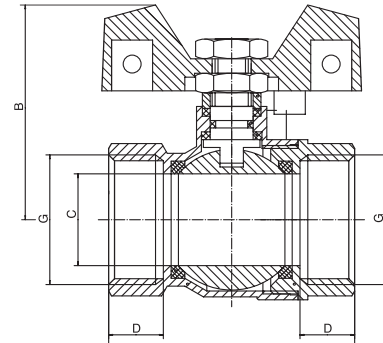

### VÁLVULA ESFÉRICA PASO TOTAL M-H MARIPOSA

MODELO	RF-100B M-H	CÓDIGO	MEDIDA	B (mm)	C (mm)	D (mm)	E (mm)	F (mm)	H (mm)	G (pulg.)	L (mm)
		13310012	1/2"	38	10.6	14	10.6	14	14	1/2"	49
		13310034	3/4"	40	10.6	14	10.6	14	17	3/4"	55
		1331001	1"	48	15.7	18.5	15.7	18.5	20	1"	65



Cuerpo, bonete y bola de bronce. Asiento de bola de P.T.F.E. Vástago, arandela y tuerca de fijación de bronce. Manija de aluminio.

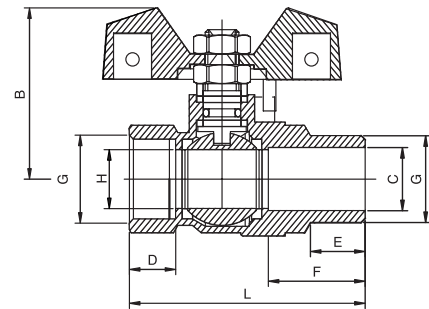

### VÁLVULA ESFÉRICA CON MEDIA UNIÓN M-H MARIPOSA

MODELO	RF-366	CÓDIGO	MEDIDA	A (mm)	B (mm)	C (mm)	D (mm)	G (pulg.)	L (mm)
		1736612	1/2"	25	41,2	13,4	13,5	1/2	70
		1736634	3/4"	30	46,1	17	13,5	3/4	75
		173661	1"	31	51	23	16,2	1	89



Cuerpo de bronce. Bola de bronce cromada. Asiento de bola de P.T.F.E. Vástago de bronce. Manija de aluminio pintada.

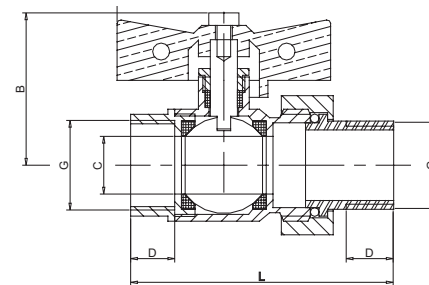

### VÁLVULA ESCLUSA PASO TOTAL

MODELO	ESCL-402	CÓDIGO	MEDIDA	A (mm)	B (mm)	C (mm)	G (pulg.)	L (mm)
		1540212	1/2"	54	64.5	12.5	1/2"	37
		1540234	3/4"	53	66	15	3/4"	37.5
		154021	1"	59	72	19	1"	42.5
		15402114	1 1/4"	68,65	117	31	1 1/4"	56
		15402112	1 1/2"	80	105.5	31	1 1/2"	52.5
		154022	2"	100	142	47	2"	64
		15402212	2 1/2"	97,8	160	56,5	2 1/2"	73
		154023	3"	110	178	68	3"	73
		154024	4"	131	220,5	89	4"	82



Cuerpo, cuchilla, vástago y tapa superior de bronce. O-ring de N.B.R. Tuerca de cierre de bronce. Manija de hierro pintada. Tuerca de Manija de bronce.

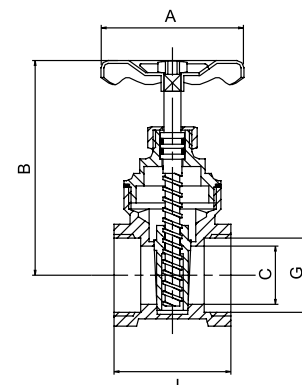

■ GAS ■ AGUA

VÁLVULA DE RETENCIÓN A CLAPETA

MODELO	ZMP 118	CÓDIGO	MEDIDA	A (mm)	C (mm)	L (mm)	G (pulg.)
		1811812	1/2"	33	13	46,5	1/2"
		1811834	3/4"	35	18,5	52	3/4"
		181181	1"	41,25	22	57	1"
		18118114	1 1/4"	46,75	29	65,5	1 (1/4")
		18118112	1 1/2"	52,5	35	78	1 (1/2")
		181182	2"	60,5	39	82	2"
		18118212	2 1/2"	74,5	50	108	2 (1/2")
		181183	3"	82	63	125	3"
		181184	4"	104,5	83	156	4"

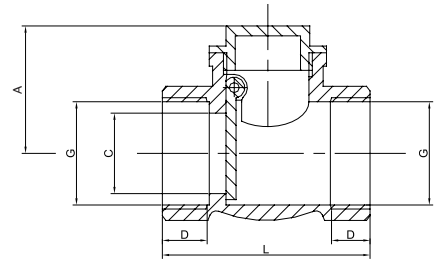

Cuerpo de bronce. Clapeta de bronce. Asiento de goma NBR.

VÁLVULA DE RETENCIÓN VÁSTAGO METÁLICO

MODELO	ZMP 116 PLUS	CÓDIGO	MEDIDA	A (mm)	C (mm)	L (mm)	G (pulg.)
		1811912	1/2"	32	17	45	1/2"
		1811934	3/4"	37,6	20	49	3/4"
		181191	1"	44	25	57	1"
		18119114	1 1/4"	53	33	63,5	1 1/4"
		18119112	1 1/2"	65	40	66	1 1/2"
		181192	2"	74,5	54	76	2"
		18119212	2 1/2"	74,5	54	76	2 1/2"
		181193	3"	109	76	90	3"
		181194	4"	141	102	109	4"

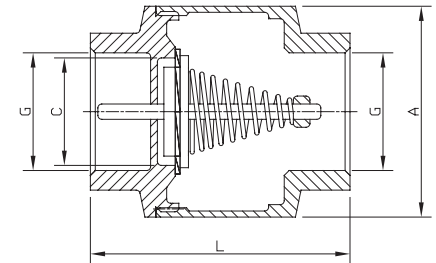

Cuerpo, bonete, vástago de bronce. Sello de cierre en EPDM. Resorte de acero inoxidable

VÁLVULA DE RETENCIÓN VÁSTAGO PLÁSTICO

MODELO	ZMP 116	CÓDIGO	MEDIDA	A (mm)	C (mm)	L (mm)	G (pulg.)
		1811612	1/2"	32	17	45	1/2"
		1811634	3/4"	37,6	20	49	3/4"
		181161	1"	44	25	57	1"
		18116114	1 1/4"	53	33	63,5	1 1/4"
		18116112	1 1/2"	65	40	66	1 1/2"
		181162	2"	74,5	54	76	2"
		18116212	2 1/2"	74,5	54	76	2 1/2"
		181163	3"	109	76	90	3"
		181164	4"	141	102	109	4"

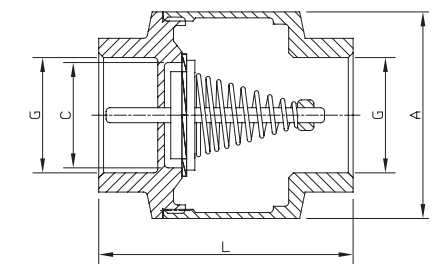

Cuerpo, bonete de bronce. Vástago de ABS. Sello de cierre en EPDM. Resorte de acero inoxidable

FILTRO PARA VÁLVULA DE RETENCIÓN

MODELO	FIL 116	CÓDIGO	MEDIDA	A (mm)	B (mm)	C (pulg.)	D (mm.)	E (mm)	L (mm)
		1811712	1/2"	24,5	27,3	1/2"	8	15	40,5
		1811734	3/4"	31	33,5	3/4"	7,5	19	43,5
		181171	1"	36,5	40,5	1"	9,5	23,5	54
		18117114	1 1/4"	43,5	48,5	1 1/4"	10	34,5	63
		18117112	1 1/2"	53,5	58	1 1/2"	10	40	69
		181172	2"	63,5	68,5	2"	11	49,5	84

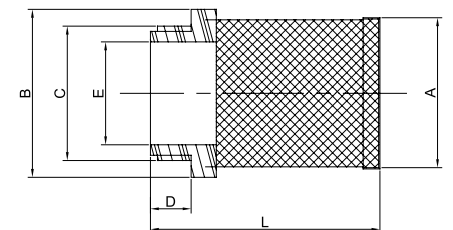

### MINI VÁLVULA ESFERICA M-M

MODELO	106 M-M	CÓDIGO	MEDIDA	D (pulg.)	D1 (mm)	H (mm)	L (mm)	S (mm)
		17106118	1/8"	1/8"	6	26	38	19
		17106114	1/4"	1/4"	8	27	41	20
		17106138	3/8"	3/8"	12	30	46	24,5
		17106112	1/2"	1/2"	15	31	47	24,5



Cuerpo de bronce cromado. Asiento de bola de P.T.F.E. Bola de bronce cromado. Vástago de bronce. O'ring de N.B.R. Manija de aluminio.

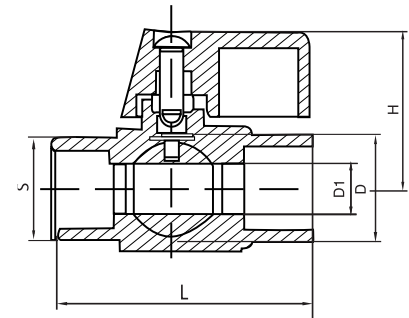

### MINI VÁLVULA ESFERICA M-H

MODELO	106 M-H	CÓDIGO	MEDIDA	D (pulg.)	D1 (mm)	H (mm)	L (mm)	S (mm)
		17106218	1/8"	1/8"	7	27	38	17
		17106214	1/4"	1/4"	8	27,6	39	17
		17106238	3/8"	3/8"	9	28	40	20
		17106212	1/2"	1/2"	10	30	44	24



Cuerpo de bronce cromado. Tuerca de cierre de bronce. Bola de bronce cromado. Asiento de P.T.F.E. Vástago de bronce. O'ring de N.B.R. Manija de aluminio.

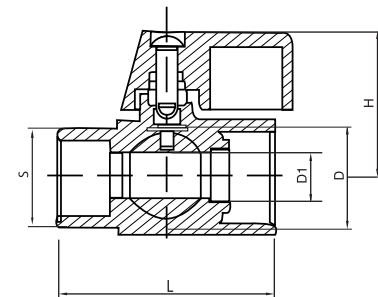

### MINI VÁLVULA ESFERICA H-H

MODELO	106 H-H	CÓDIGO	MEDIDA	D (pulg.)	D1 (mm)	H (mm)	L (mm)	S (mm)
		17106318	1/8"	1/8"	7	27	38	16
		17106314	1/4"	1/4"	8	27,5	39	16
		17106338	3/8"	3/8"	9	28	40	20
		17106312	1/2"	1/2"	10	30	46	24



Cuerpo de bronce cromado. Tuerca de cierre de bronce. Asiento de P.T.F.E. Vástago de bronce. O'ring de N.B.R. Manija de aluminio.

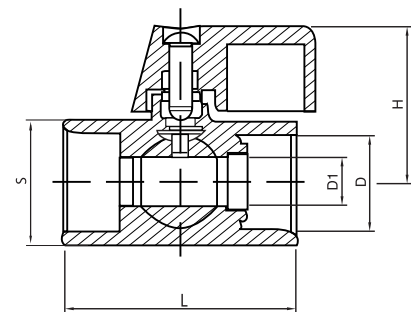

### VÁLVULA A CODO M-H PARA FLEXIBLE

MODELO	RF-301 M-H	CÓDIGO	MEDIDA	A (mm)	B (mm)	C (mm)	D (mm)	G (pulg.)	H (pulg.)	L (mm)
		13301121	1/2" x 1/2"	24,55	36,65	10,95	10	1/2"	1/2"	82,4



Cuerpo de bronce. Asiento vástago de P.T.F.E. Vástago de bronce. O'ring vástago de P.T.F.E. Manija de plástico.

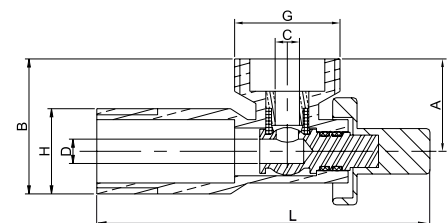

GAS

AGUA

CANILLAS Y GRIFERÍAS

CANILLA ESFÉRICA FORJADA PLUS

MODELO	LT-PLUS	CÓDIGO	MEDIDA	A (mm)	B (mm)	C (mm)	L (mm)	E (mm)	G (pulg)
		211012	1/2"	86	38	8.5	90	10	1/2"
		211034	3/4"	86	38	9.5	105	10.5	3/4"
		21101	1"	110	54	13.5	113.5	12.5	1"



Cuerpo, Bonete y bola de bronce cromado. Asiento de bola de P.T.F.E. Vástago de latón. O'ring de N.B.R. Manija de acero cromado cubierta de PVC. Tuerca de manija de bronce cromado. Filtro/cortachorro de plástico. O'ring espiga de N.B.R. Tuerca de espiga de bronce. Espiga de bronce para manguera.

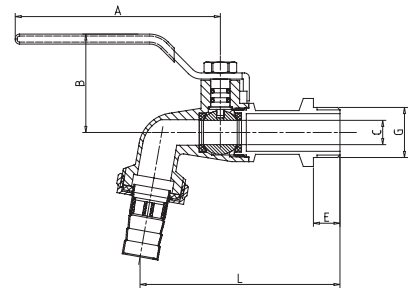

CANILLA ESFÉRICA MARIPOSA

MODELO	LT-M	CÓDIGO	MEDIDA	A (mm)	B (mm)	C (mm)	L (mm)	E (mm)	G (pulg)
		211212	1/2"	25.2	34.5	8.5	84	9.5	1/2
		211234	3/4"	25.2	35.5	9.5	100	10.5	3/4



Cuerpo, bonete y bola de bronce cromado. Asiento bola de P.T.F.E. Vástago de bronce. O'ring de N.B.R. Tuerca fijación de bronce. Espiga de bronce. guarnición de espiga de N.B.R. Tuerca espiga de bronce. Manija de aluminio pintada. Con prensaestopa.

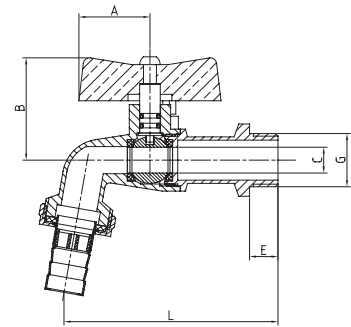

CANILLA ESFÉRICA PARA LAVARROPA PALANCA

MODELO	LT-LAV P	CÓDIGO	MEDIDA	A (pulg.)	B (mm)	C (mm)	L (mm)	E (mm)	G (pulg)
		212012	1/2 x 3/4	79	42,5	14	95,65	12,5	1/2



Cuerpo, Bonete y bola de bronce cromado. Asiento y bola P.T.F.E. Vástago de bronce. Manija de aluminio pintada rojo. Manija a lavarropas de plástico rojo. Doble O-ring de N.B.R. Tuerca de espiga de bronce. Guarnición de espiga de N.B.R. Corta chorros de plástico y Espiga de bronce.

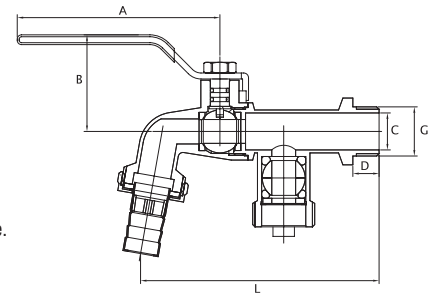

CIERRE  
SEGURO,  
GARANTÍA  
TOTAL

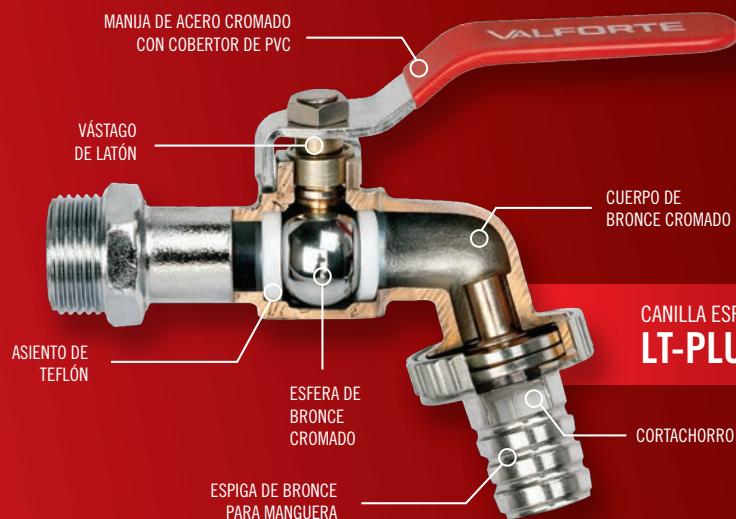

CANILLA ESFÉRICA  
LT-PLUS

### CANILLA ESFERICA PARA NICHOS

MODELO	LT-NIC	CÓDIGO	MEDIDA
		211412	1/2
		211434	3/4



### CANILLA PARA RIEGO PALANCA

MODELO	LT-100 P	CÓDIGO	MEDIDA
		215012	1/2
		215034	3/4



### CANILLA PARA RIEGO MARIPOSA

MODELO	LT-100 M	CÓDIGO	MEDIDA
		215112	1/2
		215134	3/4



### CANILLA PARA RIEGO MARIPOSA

MODELO	VW-408 M	CÓDIGO	MEDIDA
		2140812	1/2
		2140834	3/4



### CANILLA PARA RIEGO PALANCA

MODELO	VW-408 P	CÓDIGO	MEDIDA
		21408121	1/2
		21408341	3/4



### CANILLA DE BRONCE CON PICO

MODELO	GR-338 PLUS	CÓDIGO	MEDIDA
		2033812	1/2
		2033834	3/4



### CANILLA DE BRONCE CROMADA CON PICO

MODELO	GR-339	CÓDIGO	MEDIDA
		2033912	1/2
		2033934	3/4



### GRIFERÍA COCINA MESAADA J

MODELO	GR-600	CÓDIGO	A (cm)	B (cm)
		47600	30	16



### GRIFERÍA COCINA PARED PICO BAJO S

MODELO	GR-601	CÓDIGO	A (cm)	B (cm)
		47601	17.5	26

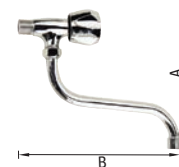

### GRIFERÍA COCINA PARED PICO ALTO U

MODELO	GR-602	CÓDIGO	A (cm)	B (cm)
		47602	12	26



### GRIFERÍA DOBLE PARA LAVARROPA CON PICO MOVIL S

MODELO	GR-2060	CÓDIGO	A (cm)	B (cm)
		222060	18.5	30.5

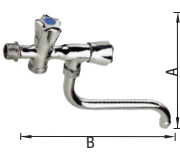

### GRIFERÍA LAVATORIO - VOLANTE CRUZ

MODELO	GR-317	CÓDIGO	A (cm)	B (cm)
		22300712	7	11.5



### GRIFERÍA LAVATORIO - VOLANTE

MODELO	GR-318	CÓDIGO	A (cm)	B (cm)
		22318112	6	11.5



### GRIFERÍA SIMPLE PARA LAVARROPA

MODELO	GR-2052	CÓDIGO	A (cm)	B (cm)
		22205212	7	8



### GRIFERÍA DOBLE PARA LAVARROPA

MODELO	GR-2050	CÓDIGO	A (cm)	B (cm)
		22205012	8	11



### GRIFERÍA DOBLE PARA LAVARROPA CON PICO

MODELO	GR-2051	CÓDIGO	A (cm)	B (cm)
		22205112	11	11.5



### VÁLVULA ESCUADRA PARA LAVARROPAS

MODELO	GR-2053	CÓDIGO	A (cm)	B (cm)
		222053	11	11.5

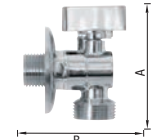

REPUESTOS

PICO P/GRIFERÍA MESA DA J

MODELO	PI-1600	CÓDIGO	A (cm)	B (cm)	C (cm)
		21301600	14	14	19,5



PICO P/GRIFERÍA MESA DA J LARGO

MODELO	PI-1604	CÓDIGO	A (cm)	B (cm)	C (cm)
		21301604	20	16	25,5



PICO P/GRIFERÍA PARED BAJO S

MODELO	PI-1601	CÓDIGO	MEDIDA
		21301601	-



PICO P/GRIFERÍA PARED ALTO U

MODELO	PI-1602	CÓDIGO	MEDIDA
		21301602	-



PICO FLEXIBLE P/GRIFERIA J

MODELO	PI-1603	CÓDIGO	MEDIDA
		21301603	-



PROLONGACIONES TREFILADAS CROMADAS

MOD.	LT-EX	CÓDIGO	MEDIDA
		21301215	1/2 x 1/2"
		21301220	1/2 x 3/4"
		21301225	1/2 x 1"
		21301230	1/2 x 1 1/4"
		21301240	1/2 x 1 1/2"
		21301250	1/2 x 2"
		21301275	1/2 x 3"
		21301210	1/2 x 4"
		21303450	3/4 x 3/4"
		21303440	3/4 x 1"
		21303430	3/4 x 1 1/4"
		21303425	3/4 x 1 1/2"
		21303420	3/4 x 2"



BOTÓN PARA DEPOSITO DE INODORO

MOD.	BDI-400	CÓDIGO	MEDIDA
		30400	CORTO
		30401	LARGO



PICO PARA CANILLA

MODELO	LT-405	CÓDIGO	MEDIDA
		210012	1/2
		210034	3/4
		21001	1



HERRAMIENTAS SANITARIAS

LLAVE PARA LAVATORIO

MODELO	WR-0077	CÓDIGO	MEDIDA
		35130077	254mm-10"



CINTA PERFORADA GALVANIZADA 17x0.7MM

MODELO	PL-0320	CÓDIGO	MEDIDA
		35032010	10mm
		35032025	25mm



ABOCINADOR P/TUBOS DE COBRE Y ALUMINIO

MODELO	PL-7001	CÓDIGO	MEDIDA
		35037001	-



**CABEZALES Y CARTUCHOS**
**CABEZAL EFE LARGO ESTRIA FINA**

MODELO	<b>EFE-2079 EF</b>	CÓDIGO
		30201

**CABEZAL EFE CORTO ESTRIA FINA**

MODELO	<b>EFE-2078 EF</b>	CÓDIGO
		30202

**CABEZAL EFE TRANSFERENCIA BIDET**

MODELO	<b>EFE-2106</b>	CÓDIGO
		30203

**CABEZAL EFE TRANSFERENCIA DUCHA**

MODELO	<b>EFE-2062</b>	CÓDIGO
		30204

**CABEZAL EFE LARGO ESTRIA GRUESA**

MODELO	<b>EFE-2079 EG</b>	CÓDIGO
		30301

**CABEZAL EFE CORTO ESTRIA GRUESA**

MODELO	<b>EFE-2078 EG</b>	CÓDIGO
		30302

**CABEZAL PEI COMÚN CON PRENSA**

MODELO	<b>PE-2071</b>	CÓDIGO
		30101

**CABEZAL PEI MESADA CON ROSCA**

MODELO	<b>PE-2072</b>	CÓDIGO
		30102

**CABEZAL PEI TRANSFERENCIA BIDET**

MODELO	<b>PE-2073</b>	CÓDIGO
		30103

**CABEZAL PEI TRANSFERENCIA DUCHA**

MODELO	<b>PE-2067</b>	CÓDIGO
		30104

**CABEZAL EFE AL P/LAVATORIO-BIDET**

MODELO	<b>EFE-2129</b>	CÓDIGO
		30303

**CABEZAL EFE AL P/DUCHA DE EMBUTIR**

MODELO	<b>EFE-2139</b>	CÓDIGO
		30304

**CABEZAL EFE LLUVIA INTERMEDIA**

MODELO	<b>EFE-2101</b>	CÓDIGO
		30305

**CABEZAL EFE LAVATORIO BIDET**

MODELO	<b>EFE-2049</b>	CÓDIGO
		30306

**CABEZAL PZA CORTO COMPRESIÓN**

MODELO	<b>PH-2114</b>	CÓDIGO
		30411

**CABEZAL PZA LARGO P/LAVATORIO-BIDET**

MODELO	<b>PH-2093</b>	CÓDIGO
		30412

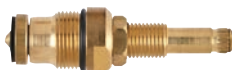
**CABEZAL PZA CIERRE CERÁMICO FRÍA**

MODELO	<b>PH-2133F</b>	CÓDIGO
		30413

**CABEZAL PZA CIERRE CERÁMICO CALIENTE**

MODELO	<b>PH-2133C</b>	CÓDIGO
		30414

**CABEZAL CORTO CIERRE CERÁMICO FRÍA**

MODELO	<b>CC-4248F</b>	CÓDIGO
		30501

**CABEZAL CORTO CIERRE CERÁMICO CALIENTE**

MODELO	<b>CC-4248C</b>	CÓDIGO
		30502

**CARTUCHO P/MONO C/TRANSICIÓN**

MODELO	<b>MON-T</b>	CÓDIGO
		306035

**CARTUCHO P/MONO S/TRANSICIÓN**

MODELO	<b>MON-C</b>	CÓDIGO
		306135 306140



GAS

AGUA

TERMOCUPLAS

TERMOCUPLA CON SOPORTE M8

Mod.	TC -GAS SSO	Código	MEDIDA
		20100200	200
		20100300	300
		20100400	400
		20100500	500
		20100600	600
		20100700	700
		20100800	800
		20100900	900
		20101000	1000
		20101100	1100
		20101200	1200
		20101300	1300
		20101400	1400
		20101500	1500



IN  
TER  
CAM  
BIA  
BLES

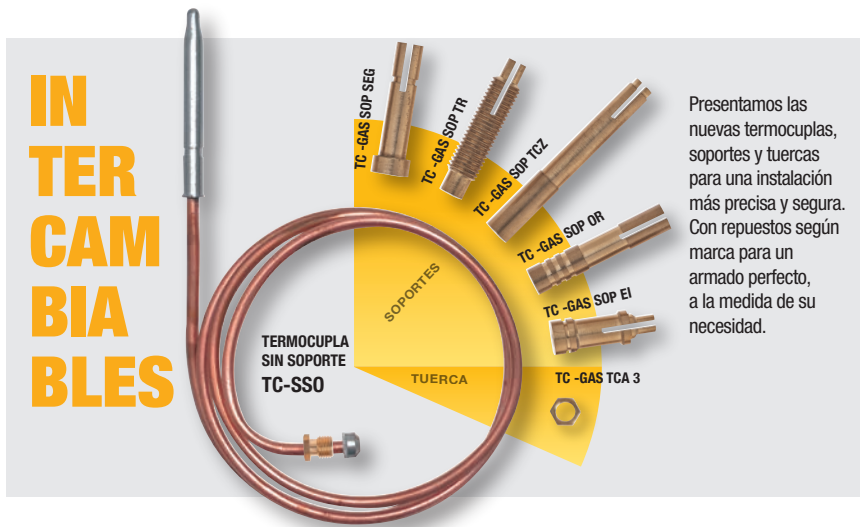

Presentamos las nuevas termocuplas, soportes y tuercas para una instalación más precisa y segura. Con repuestos según marca para un armado perfecto, a la medida de su necesidad.

SOPORTES Y TUERCAS

SOPORTE ROSCADO P/TERMOCUPLA

Mod.	TC -GAS SOP TR	Código	MEDIDA
		2016109	-



SOPORTE P/TERMOCUPLA - CALEFAC. ORB.

Mod.	TC -GAS SOP OR	Código	MEDIDA
		2016110	-



SOPORTE P/TERMOCUPLA - TERMO.EI.

Mod.	TC -GAS SOP EI	Código	MEDIDA
		2016111	-



SOPORTE P/TERMOCUPLA - SEGUER

Mod.	TC -GAS SOP SEG	Código	MEDIDA
		2016112	-



SOPORTE P/TERMOCUPLA TCZ

Mod.	TC -GAS SOP TCZ	Código	MEDIDA
		2016113	-



TUERCA PASANTE P/ TERMOCUPLA

Mod.	TC -GAS TCA1	Código	MEDIDA
		2016105	M9
		2016108	M8



TUERCA PARTIDA P/ TERMOCUPLA

Mod.	TC -GAS TCA2	Código	MEDIDA
		2016106	M9



TUERCA PLANA P/TERMOCUPLA

Mod.	TC -GAS TCA3	Código	MEDIDA
		2016107	M8



ENCENDIDOS PIEZO ELÉCTRICOS

PIEZO ELÉCTRICO ESTRELLITA

Mod.	PZ-ES	Código	MEDIDA
		2130100	-



PIEZO ELÉCTRICO PUNTA HUECA

Mod.	PZ-PU	Código	MEDIDA
		2130101	-



PIEZO ELÉCTRICO ESTRELLITA CON MAZA

Mod.	PZ-ESM	Código	MEDIDA
		2130102	-



UNIDAD MAGNÉTICA

Mod.	UM	Código	MEDIDA
		20162011	11
		20162014	14



DOS OPCIONES, UNA  
MISMA CONFIANZA



CH 000000 C  
LATYN  
IGA  
1583/01  
Epoxy  
Mediolo Aprobado  
Made in  
China



**Latyn**  
GALVANIZADO | EPOXI

EPOXI

GALVANIZADOS

ACCESORIOS EPOXI

CODO H-H 90°

MODELO	E-90	CÓDIGO	MEDIDA
		109012	1/2
		109034	3/4
		10901	1
		1090114	1 1/4
		1090112	1 1/2
		10902	2
		1090212	2 1/2
		10903	3
		10904	4

CODO M-H 90°

MODELO	E-92	CÓDIGO	MEDIDA
		109212	1/2
		109234	3/4
		10921	1
		1092114	1 1/4
		1092112	1 1/2
		10922	2
		1092212	2 1/2
		10923	3
		10924	4

TEE H-H-H

MODELO	E-130	CÓDIGO	MEDIDA
		1013012	1/2
		1013034	3/4
		101301	1
		10130114	1 1/4
		10130112	1 1/2
		101302	2
		10130212	2 1/2
		101303	3
		101304	4

CUPLA H-H

MODELO	E-270	CÓDIGO	MEDIDA
		1027012	1/2
		1027034	3/4
		102701	1
		10270114	1 1/4
		10270112	1 1/2
		102702	2
		10270212	2 1/2
		102703	3
		102704	4

ROSCA CON TUERCA

MODELO	E-280	CÓDIGO	MEDIDA
		1028012	1/2
		1028034	3/4
		102801	1
		10280114	1 1/4
		10280112	1 1/2
		102802	2
		10280212	2 1/2
		102803	3
		102804	4

TAPÓN M

MODELO	E-290	CÓDIGO	MEDIDA
		1029012	1/2
		1029034	3/4
		102901	1
		10290114	1 1/4
		10290112	1 1/2
		102902	2
		10290212	2 1/2
		102903	3
		102904	4

TAPA H

MODELO	E-301	CÓDIGO	MEDIDA
		1030112	1/2
		1030134	3/4
		103011	1
		10301114	1 1/4
		10301112	1 1/2
		103012	2

TUERCA

MODELO	E-310	CÓDIGO	MEDIDA
		1031012	1/2
		1031034	3/4
		103101	1
		10310114	1 1/4
		10310112	1 1/2
		103102	2

UNIÓN DOBLE CÓNICA H-H

MODELO	E-340	CÓDIGO	MEDIDA
		1034012	1/2
		1034034	3/4
		103401	1
		10340114	1 1/4
		10340112	1 1/2
		103402	2
		10340212	2 1/2
		103403	3
		103404	4

REDUCCIONES EPOXI

BUJE M-H REDUCCIÓN

MODELO	E-241R	CÓDIGO	MEDIDA
		102413412	3/4 x 1/2
		102410112	1 x 1/2
		10241134	1 x 3/4
		1024111412	1 1/4 x 1/2
		1024111434	1 1/4 x 3/4
		102411141	1 1/4 x 1
		1024111234	1 1/2 x 3/4
		102411121	1 1/2 x 1
		10241112114	1 1/2 x 1 1/4
		1024121	2 x 1
		102412114	2 x 1 1/4
		102412112	2 x 1 1/2
		10241212114	2 1/2 x 1 1/4
		10241212112	2 1/2 x 1 1/2
		102412122	2 1/2 x 2
		102413112	3 x 1 1/2
		1024132	3 x 2
		102413212	3 x 2 1/2
		102414112	4 x 1 1/2
		1024142	4 x 2
		102414212	4 x 2 1/2
		1024143	4 x 3

TEE REDUCCIÓN

MODELO	E-130R	CÓDIGO	MEDIDA
		101303412	3/4 x 1/2
		101300112	1 x 1/2
		10130134	1 x 3/4
		1013011412	1 1/4 x 1/2
		1013011434	1 1/4 x 3/4
		101301141	1 1/4 x 1
		1013011234	1 1/2 x 3/4
		101301121	1 1/2 x 1
		10130112114	1 1/2 x 1 1/4
		3/41013021	2 x 1
		101302114	2 x 1 1/4
		101302112	2 x 1 1/2

CODO H-H 90° REDUCCION

MODELO	E-90R	CÓDIGO	MEDIDA
		10903412	3/4 x 1/2
		10900112	1 x 1/2
		1090134	1 x 3/4
		10901121	1 1/2 x 1
		1090112114	1 1/2 x 1 1/4

CUPLA H-H REDUCCIÓN

MODELO	E-240R	CÓDIGO	MEDIDA
		102403412	3/4 x 1/2
		102400112	1 x 1/2
		10240134	1 x 3/4

**ACCESORIOS GALVANIZADOS**
**CURVA M-H 90°**

MODELO	G-1	CÓDIGO	MEDIDA
		11112	1/2
		11134	3/4
		11111	1
		111114	1 1/4
		111112	1 1/2
		11112	2
		111212	2 1/2
		11113	3
		11114	4
		11116	6

**CURVA H-H 90°**

MODELO	G-2	CÓDIGO	MEDIDA
		11212	1/2
		11234	3/4
		1121	1
		112114	1 1/4
		112112	1 1/2
		1122	2
		112212	2 1/2
		1123	3
		1124	4

**CURVA M-H 45°**

MODELO	G-40	CÓDIGO	MEDIDA
		114012	1/2
		114034	3/4
		11401	1
		1140114	1 1/4
		1140112	1 1/2
		11402	2
		1140212	2 1/2
		11403	3
	11404	4	

**CURVA H-H 45°**

MODELO	G-41	CÓDIGO	MEDIDA
		114112	1/2
		114134	3/4
		11411	1
		1141114	1 1/4
		1141112	1 1/2
		11412	2
		1141212	2 1/2
		11413	3
		11414	4

**CODO H-H 90°**

MODELO	G-90	CÓDIGO	MEDIDA
		119014	1/4
		119038	3/8
		119012	1/2
		119034	3/4
		11901	1
		1190114	1 1/4
		1190112	1 1/2
		11902	2
		1190212	2 1/2
		11903	3
		11904	4
		11906	6

**CODO M-H 90°**

MODELO	G-92	CÓDIGO	MEDIDA
		119214	1/4
		119238	3/8
		119212	1/2
		119234	3/4
		11921	1
		1192114	1 1/4
		1192112	1 1/2
		11922	2
		1192212	2 1/2
		11923	3
	11924	4	

**TEE H-H-H**

MODELO	G-130	CÓDIGO	MEDIDA
		1113014	1/4
		1113038	3/8
		1113012	1/2
		1113034	3/4
		111301	1
		11130114	1 1/4
		11130112	1 1/2
		111302	2
		11130212	2 1/2
		111303	3
		111304	4
		111306	6

**CRUZ**

MODELO	G-180	CÓDIGO	MEDIDA
		1118012	1/2
		1118034	3/4
		111801	1
		11180114	1 1/4
		11180112	1 1/2
		111802	2

**CUPLA H-H**

MODELO	G-270	CÓDIGO	MEDIDA
		1127038	3/8
		1127012	1/2
		1127034	3/4
		112701	1
		11270114	1 1/4
		11270112	1 1/2
		112702	2
		11270212	2 1/2
		112703	3
		112704	4
	112706	6	

**ROSCA CON TUERCA**

MODELO	G-280	CÓDIGO	MEDIDA
		1128012	1/2
		1128034	3/4
		112801	1
		11280114	1 1/4
		11280112	1 1/2
		112802	2
		11280212	2 1/2
		112803	3
		112804	4
		112806	6

**TAPÓN M**

MODELO	G-290	CÓDIGO	MEDIDA
		1129012	1/2
		1129034	3/4
		112901	1
		11290114	1 1/4
		11290112	1 1/2
		112902	2
		11290212	2 1/2
		112903	3
		112904	4

**TAPA H**

MODELO	G-301	CÓDIGO	MEDIDA
		1130112	1/2
		1130134	3/4
		113011	1
		11301114	1 1/4
		11301112	1 1/2
		113012	2
		11301212	2 1/2
		113013	3
		113014	4

**TUERCA**

MODELO	G-310	CÓDIGO	MEDIDA
		1131012	1/2
		1131034	3/4
		113101	1
		11310114	1 1/4
		11310112	1 1/2
		113102	2

**BRIDA**

MODELO	G-321	CÓDIGO	MEDIDA
		1132112	1/2
		1132134	3/4
		113211	1
		11321114	1 1/4
		113212	2
		11321212	2 1/2
		113213	3
		113214	4

**UNIÓN DOBLE CÓNICA H-H**

MODELO	G-340	CÓDIGO	MEDIDA
		1134012	1/2
		1134034	3/4
		113401	1
		11340114	1 1/4
		11340112	1 1/2
		113402	2
		11340212	2 1/2
		113403	3
		113404	4

EPOXI

GALVANIZADOS

REDUCCIONES GALVANIZADOS

CODO H-H 90° REDUCCIÓN

MODELO	G-90R	CÓDIGO	MEDIDA
		11903412	3/4 X 1/2
		1190134	1 X 3/4



TEE REDUCCIÓN

MODELO	G-130R	CÓDIGO	MEDIDA
		111303412	3/4 X 1/2
		111300112	1 X 1/2
		11130134	1 X 3/4
		111301141	1 1/4 X 1
		111301121	1 1/2 X 1
		11130112114	1 1/2 X 1 1/4
		1113021	2 X 1
		111302112	2 X 1 1/2
		111302122	2 1/2 X 2
		111303112	3 X 1 1/2
		1113032	3 X 2
		111303212	3 X 2 1/2
		1113042	4 X 2
		1113043	4 X 3



CUPLA H-H REDUCCIÓN

MODELO	G-240R	CÓDIGO	MEDIDA
		112403412	3/4 X 1/2
		112400112	1 X 1/2
		11240134	1 X 3/4
		112401141	1 1/4 X 1
		112401121	1 1/2 X 1
		11240112114	1 1/2 X 1 1/4
		1124021	2 X 1
		112402114	2 X 1 1/4
		112402112	2 X 1 1/2
		112402122	2 1/2 X 2
		1124032	3 X 2
		112403212	3 X 2 1/2
		1124042	4 X 2
		112404212	4 X 2 1/2
		1124043	4 X 3



BUJE M-H REDUCCIÓN

MODELO	G-241R	CÓDIGO	MEDIDA
		112411214	1/2 X 1/4
		112411238	1/2 X 3/8
		112413412	3/4 X 1/2
		112410112	1 X 1/2
		11241134	1 X 3/4
		1124111412	1 1/4 X 1/2
		1124111434	1 1/4 X 3/4
		112411141	1 1/4 X 1
		1124111212	1 1/2 X 1/2
		1124111234	1 1/2 X 3/4
		112411121	1 1/2 X 1
		11241112114	1 1/2 X 1 1/4
		112410212	2 X 1/2
		11241234	2 X 3/4
		1124121	2 X 1
		112412114	2 X 1 1/4
		112412112	2 X 1 1/2
		112412121	2 1/2 X 1
		11241212114	2 1/2 X 1 1/4
		11241212112	2 1/2 X 1 1/2
		112412122	2 1/2 X 2
		1124131	3 X 1
		112413112	3 X 1 1/2
		1124132	3 X 2
		112413212	3 X 2 1/2
		1124142	4 X 2
		112414212	4 X 2 1/2
		1124143	4 X 3
		1124164	6 X 4



UNIONES  
DURADERAS



CONEXIONES Y CANILLAS

VÁLVULA ESFÉRICA COMPACTA PVC

MODELO	JS-500	CÓDIGO	MEDIDA	A (mm)	B (mm)	C (mm)	G (pulg)	L (mm)
		50112	1/2	70	46,5	15	1/2	80
		50134	3/4	60	46	20	3/4	77
		50111	1	77	54	24	1	90
		501114	1 1/4	98	72.5	30	1 1/4	109
		501112	1 1/2	98	78.5	34	1 1/2	112
		5012	2	121	89	45	2	139
		501212	2 1/2	119	105	60	2 1/2	118
		5013	3	119	111	65	3	222
		5014	4	224	148	86	4	300



Válvula roscada, fabricada completamente en PVC.

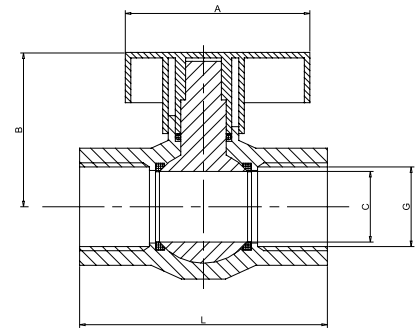

ACOPLE RÁPIDO STANDARD PARA PP

MODELO	JS-1300	CÓDIGO	MEDIDA	A (mm)	C (mm)	L (mm)
		530012	1/2	23.5	23	62
		530034	3/4	29,5	23	73
		53001	1	36.5	23	75



Fabricada completamente en plástico y sellos de MPE

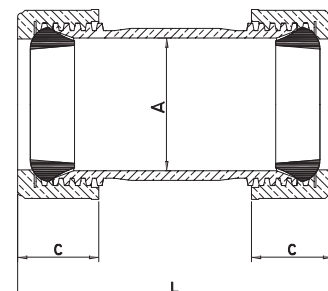

ACOPLE RÁPIDO PRO PARA PP/METAL

MODELO	JS-1400	CÓDIGO	MEDIDA	A (mm)	C (mm)	L (mm)
		540012	1/2	23.5	23	62
		540034	3/4	29,5	23	73



Fabricada completamente en plástico y sellos de MPE

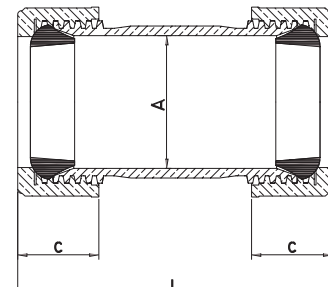

CANILLA ESFÉRICA DE PVC CON PICO

MODELO	JS-600	CÓDIGO	MEDIDA	A (mm)	B (mm)	C (mm)	G (mm)	L (mm)
		50812	1/2	48	36,5	13	1/2	103
		50834	3/4	48	36,5	14	3/4	113



Canilla fabricada completamente en PVC

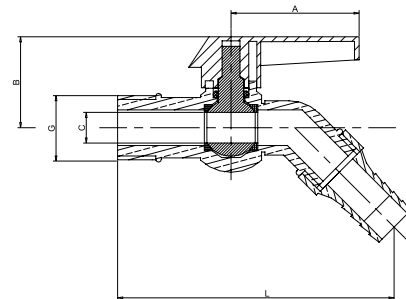

CINTAS DE TEFLÓN

TEFLÓN ALTA DENSIDAD

MODELO	FLON-AD	CÓDIGO	MEDIDA
		251012	1/2 x 10
		2510121	1/2 x 10
		25401121	1/2 X 40
		2510341	3/4 X 10
		2540341	3/4 X 40
		251011	1 x 10



FLON STANDARD

MODELO	FLON	CÓDIGO	MEDIDA
		251012	1/2 x 10
		252012	1/2 x 20
		251034	3/4 x 10
		252034	3/4 x 20
		25101	1 x 10
		25201	1 x 20



**FLOTANTES**
**FLOTANTE SILENCIOSO**

Mod.	FLOT-SILENT	CÓDIGO	MEDIDA
		332012	Hembra 1/2
		3320121	Macho 1/2

**FLOTANTE PARA TANQUE**

MODELO	FLOTANK	CÓDIGO	MEDIDA
		341012	1/2
		341034	3/4

**FLOTANTE CON BOYA**

MODELO	FLOT-BO	CÓDIGO	MEDIDA
		342012	1/2
		342032	3/4

**FLOTANTE COMPACTO PARA TANQUE**

Mod.	FLOTYN	CÓDIGO	MEDIDA
		332112	1/2
		332134	3/4



## FLOTANTE COMPACTO PARA TANQUE

ACTIVA Y CORTA EL FLUJO DE LÍQUIDOS EN RESERVORIOS O TANQUES



RESISTE ALTA PRESIÓN  
**10kg/cm<sup>2</sup>**

**FLOTYN**

RINDE UN **15%** MÁS DE VOLUMEN DE CARGA



Mayor volumen de almacenamiento de carga en el tanque, que los flotantes convencionales

**USOS**

- Tanques de agua • Bebederos de animales • Depósitos de descarga de inodoros • Tanques de reserva industriales



SOPAPAS

SOPAPA PVC LAVATORIO P/PEGAR

MODELO	SOP-ACE	CÓDIGO	MEDIDA
		507040	40
		507050	50



SOPAPA PVC LAVAT. C/ ROSCA ACERO INOX.

MODELO	SOP-ACE R	CÓDIGO	MEDIDA
		5080114	1 1/4
		5080112	1 1/2



SOPAPA PVC BAÑERA A CODO ACERO INOX.

MODELO	SOP ACE C	CÓDIGO	MEDIDA
		509040	40



TUBOS EXTENSIBLES

TUBO EXTENSIBLE C/TUERCA

MODELO	TB-EX 4512	CÓDIGO
		19254512



para sopapa de rosca

A (mm)	B (mm)	G (mm)	C (mm)	D (mm)	L (mm)
50	40	1 1/2" H	49.6	50	320-900

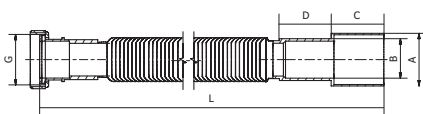

TUBO EXTENSIBLE C/TUERCA Y ROSETA

MODELO	TB-EX 4514	CÓDIGO
		1925414



para sopapa de rosca

A (mm)	B (mm)	G (mm)	L (mm)
40	1 1/4" H	76	320-900

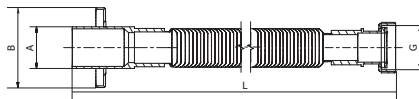

TUBO EXTENS. C/TUERCA Y ROSETA CROMADA

MODELO	TB-EX 4514 C	CÓDIGO
		34254514



para sopapa de rosca

A (mm)	B (mm)	G (mm)	L (mm)
40	76	1 1/4" H	400-900

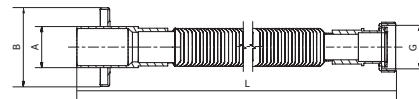

TUBO EXTENSIBLE UNIVERSAL

MODELO	TB-EX 4545	CÓDIGO
		19254545



para sopapa de pegar

A (mm)	B (mm)	L (mm)
50/40	50/40	370-900

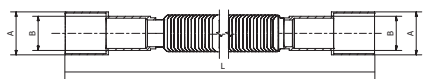

TUBO EXTENSIBLE UNIVERSAL CROMADO

MODELO	TB-EX 4545 C	CÓDIGO
		34254545



para sopapa de pegar

A (mm)	B (mm)	L (mm)
50/40	50/40	370-900

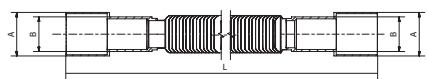

TUBO EXTENSIBLE C/ AJUSTE Y ROSETA

MODELO	TB-EX 4040	CÓDIGO
		19254040



para sopapa de pegar

A (mm)	B (mm)	L (mm)
40	40	300-700

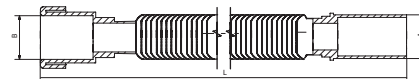

TUBO EXT. C/ AJUSTE Y ROSETA CROMADO

MODELO	TB-EX 4040 C	CÓDIGO
		34253535



para sopapa de pegar

A (mm)	B (mm)	L (mm)
40	40	300-700

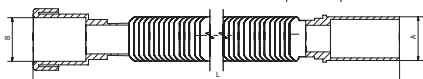

COMPLEMENTOS  
ESENCIALES

COMPLEMENTOS  
ESENCIALES  
ESENCIALES



GRIFERÍAS Y REPUESTOS

Estética y  
funcionalidad



GRIFERÍA LAVATORIO ABS VOLANTE CRUZ

MODELO	LB-5317	CÓDIGO	A (cm)	B (cm)
		5317	7,6	12,7



GRIFERÍA LAVATORIO ABS VOLANTE REDONDO

MODELO	LB-5318	CÓDIGO	A (cm)	B (cm)
		5318	7	12,8



GRIFERÍA LAVATORIO ABS BLANCA

MODELO	LB-5318 B	CÓDIGO	A (cm)	B (cm)
		53181	7	12,8



GRIFERÍA LAVADERO PARED PICO ALTO

MODELO	LB-5602	CÓDIGO	A (cm)	B (cm)
		5602	16	25



GRIFERÍA LAVADERO PARED PICO BAJO

MODELO	LB-5601	CÓDIGO	A (cm)	B (cm)
		5601	20	22,5

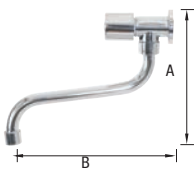

GRIFERÍA COCINA ABS PARED

MODELO	LB-5603	CÓDIGO	A (cm)	B (cm)
		5603	-	-

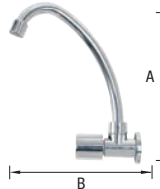

GRIFERÍA COCINA ABS PARED

MODELO	LB-5603 B	CÓDIGO	A (cm)	B (cm)
		56031	-	-

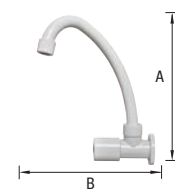

GRIFERÍA COCINA ABS MESADA

MODELO	LB-5600	CÓDIGO	A (cm)	B (cm)
		5600	25,5	18



GRIFERÍA COCINA ABS MESADA BLANCA

MODELO	LB-5600 B	CÓDIGO	A (cm)	B (cm)
		56001	23	18



GRIFERÍA COCINA ABS MESADA LUXE

MODELO	LB-5500	CÓDIGO	A (cm)	B (cm)
		5500	23,5	14



GRIFERÍA COCINA ABS PARED LUXE

MODELO	LB-5503	CÓDIGO	A (cm)	B (cm)
		5503	25	22



REPUESTO CARTUCHO CIERRE CERÁMICO

MODELO	LB-5400	CÓDIGO	MEDIDA (cm)
		5400	Universal



REPUESTO CARTUCHO CIERRE CERÁMICO LUXE

MODELO	LB-5401	CÓDIGO	MEDIDA (cm)
		5401	Universal



DUCHAS Y ACCESORIOS

FLOR DE DUCHA ABS ANTICALCÁREA CROMO

MODELO	LB-5703	CÓDIGO	MEDIDA Ø(cm)
		5703	20



FLOR DE DUCHA ABS ANTICALCÁREA CROMO

MODELO	LB-5702	CÓDIGO	MEDIDA Ø(cm)
		5702	15



FLOR DE DUCHA ABS ANTICALCÁREA CROMO

MODELO	LB-5701	CÓDIGO	MEDIDA Ø(cm)
		5701	12



FLOR DE DUCHA ABS ANTICALCÁREA CROMO

MODELO	LB-5700	CÓDIGO	MEDIDA Ø(cm)
		5700	6,5



FLOR DE DUCHA BRONCE

MODELO	DF-9000	CÓDIGO	MEDIDA (pulg)
		50412	1/2



DUCHA CROMADA BRONCE

MODELO	DF-9100	CÓDIGO	MEDIDA (pulg)
		50413	1/2



DUCHA CROMADA ABS

MODELO	DF-8108 B	CÓDIGO	A (cm)	B (cm)
		505112	13	22



DUCHADOR DE MANO ANTICALCÁREO

MODELO	LB-5704	CÓDIGO	MEDIDA (cm)
		5704	6,5



KIT DUCHADOR + DERRIVADOR + FLEX.+SOPORTE

MODELO	LB-5712	CÓDIGO	MEDIDA (cm)
		5712	-



KIT DUCHADOR + FLEXIBLE + SOPORTE

MODELO	LB-5713	CÓDIGO	MEDIDA Ø(cm)
		5713	6,5



BRAZO LLUVIA ACERO INOX. 45°

MODELO	LB-5705	CÓDIGO	MEDIDA (pulg x cm)
		5705	1/2x18
		5706	1/2x30



BRAZO LLUVIA ACERO INOX. 90°

MODELO	LB-5708	CÓDIGO	MEDIDA (pulg x cm)
		5708	1/2x30
		5709	1/2x45



CONEXIÓN DERRIVADOR DUCHA / DUCHADOR

MODELO	LB-5711	CÓDIGO	MEDIDA (pulg)
		5711	1/2



SOPORTE DUCHA ABS REGULABLE

MODELO	LB-5710	CÓDIGO	MEDIDA (pulg x cm)
		5710	1/2x30



FLEXIBLE PARA DUCHADOR

MODELO	LB-5270	CÓDIGO	MEDIDA (pulg x cm)
		505270150	1/2x150
		505270180	1/2x180
		505270200	1/2x200



ACCESORIOS PARA INODORO

BIDET ADAPTABLE P/INODORO AGUA FRÍA

MODELO	LB-290	CÓDIGO	A (cm)	B (cm)
		504273	11,6	35



BIDET ADAPTABLE P/INODORO AGUA FRÍA

MODELO	LB-295	CÓDIGO	A (cm)	B (cm)
		504295	25,2	39

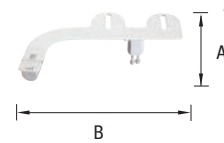

BIDET ADAPTABLE P/INODORO AGUA F/C

MODELO	LB-296	CÓDIGO	A (cm)	B (cm)
		504296	25,7	43,8

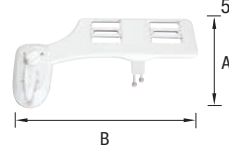

MOCHILA INODORO

MODELO	LB-5801	CÓDIGO	A (cm)	B (cm)
		5801	43	37,5



BIDET MANUAL C/FLEX+DUCHADOR+SOP+TEE

MODELO	LB-270 C	CÓDIGO	A (cm)
		504271	14



DUCHA HIGIENICA ABS+SOP+FLEXIBLE

MODELO	LB-280 C	CÓDIGO	A (cm)	B (cm)
		505280	6	10

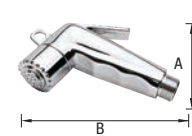

**Renová**  
cada momento  
del día



Baños sin vapor  
y más ventilados

**NUEVOS  
EXTRACTORES  
PARA BAÑO**

**LatynBio**

MODELO 420

 Exclusivo obturador trasero móvil antiplaga



COD. 4204  
4" / 20W



COD. 4206  
6" / 25W

MODELO 410

 Exclusivo filtro desmontable y lavable



COD. 4104  
4" / 20W



COD. 4106  
5" / 25W

 Frecuencia 50-60 Hz

 Tensión 220/240 V

 Luz indicadora de encendido

# LLEVAMOS EL AGUA A DONDE LA NECESITÁS



**PLUVIUS**  
SISTEMAS DE BOMBEO

## BOMBAS PRESURIZADORAS

### BOMBA PRESURIZADORA P/ TANQUE CISTERNA

#### TABLA DE CARACTERÍSTICAS

MODELO	PRES TCD	CÓDIGO	ALTURA MAX. (m)	CAUDAL (l/h)	POTENCIA (w)	CONEXIÓN (entrada y salida)	PUNTOS DE CONSUMO
--------	----------	--------	-----------------	--------------	--------------	-----------------------------	-------------------



2331

19

4500

600

1"

4

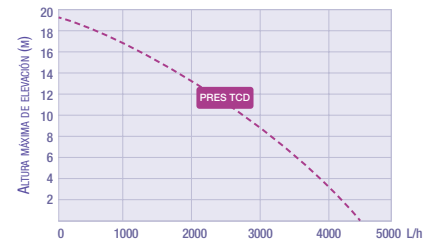

### BOMBA PRESURIZADORA P/ TANQUE ELEVADO

#### TABLA DE CARACTERÍSTICAS

MODELO	PRES TE	CÓDIGO	ALTURA MAX. (m)	CAUDAL (l/h)	POTENCIA (w)	CONEXIÓN (entrada y salida)	PUNTOS DE CONSUMO
--------	---------	--------	-----------------	--------------	--------------	-----------------------------	-------------------



100

2334

8,5

1800

100

3/4 - 1/2"

2

260

2335

13

3600

260

1 - 3/4"

3

500

2315

17

5700

500

1 - 3/4"

4

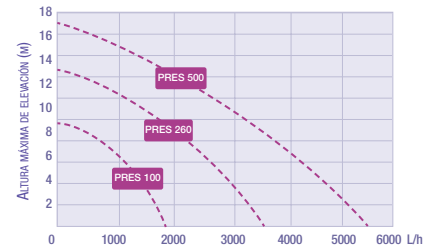

### BOMBA PRESURIZADORA TANQUE CISTERNA SUMERGIBLE

#### TABLA DE CARACTERÍSTICAS

MODELO	PRES TCS	CÓDIGO	ALTURA MAX. (m)	CAUDAL (l/h)	POTENCIA (w)	CONEXIÓN (entrada y salida)	PUNTOS DE CONSUMO
--------	----------	--------	-----------------	--------------	--------------	-----------------------------	-------------------



2349

29

5400

800

1"

5

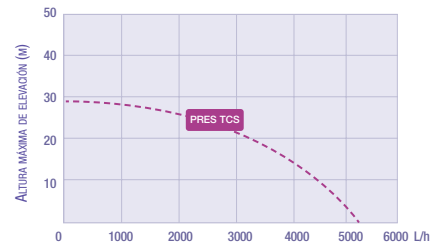

### BOMBA PRESURIZADORA VELOCIDAD VARIABLE INVERTER

#### TABLA DE CARACTERÍSTICAS

MODELO	PRES VVI	CÓDIGO	ALTURA MAX. (m)	CAUDAL (l/h)	POTENCIA (w)	CONEXIÓN (entrada y salida)	PUNTOS DE CONSUMO
--------	----------	--------	-----------------	--------------	--------------	-----------------------------	-------------------



2332

42

5100

650

1"

6

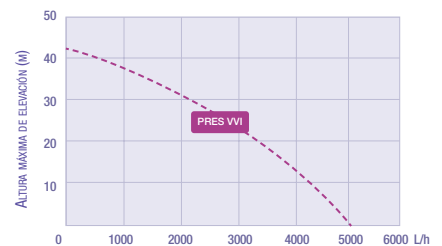

## BOMBAS ELEVADORAS

### BOMBA PERIFÉRICA

MODELO	QB	CÓDIGO	ALTURA MAX. (m)	CAUDAL (l/h)	SUCCIÓN MAX. (m)	POTENCIA (hp)	CONEXIÓN (entrada y salida)
	60	23100	28	1980	5	0,5	1"
	70	2314	42	2400	7	0,75	1"
	80	2315	50	3000	7	1	1 1/2"



TABLA DE CARACTERÍSTICAS

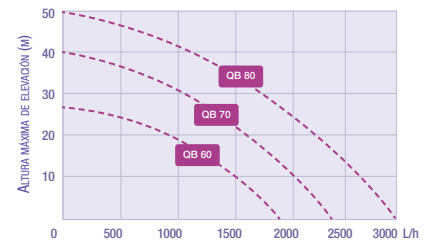

### BOMBA CENTRÍFUGA

MODELO	CPM	CÓDIGO	ALTURA MAX. (m)	CAUDAL (l/h)	SUCCIÓN MAX. (m)	POTENCIA (hp)	CONEXIÓN (entrada y salida)
	130	2324	16	4800	8	0,5	1"
	146	2325	20	5400	8	0,75	1"
	158	2327	25	5700	8	1	1"
	180	2328	35	7800	8	1,5	1"
	200	2329	40	8400	8	2	1"



TABLA DE CARACTERÍSTICAS

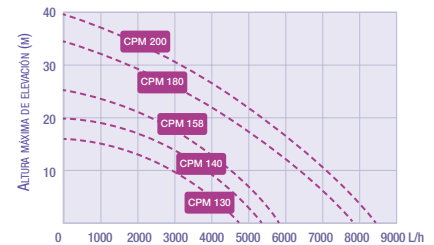

### BOMBA AUTOASPIRANTE

MODELO	JET	CÓDIGO	ALTURA MAX. (m)	CAUDAL (l/h)	SUCCIÓN MAX. (m)	POTENCIA (hp)	CONEXIÓN (entrada y salida)
	60 L	2337	40	2400	9	0,5	1"
	80 L	2338	45	2700	9	0,75	1"
	100 L	2339	48	2880	9	1	1"



TABLA DE CARACTERÍSTICAS

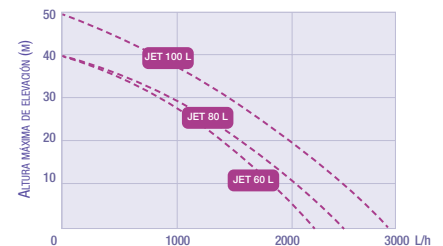



# UNA BOMBA PARA CADA NECESIDAD

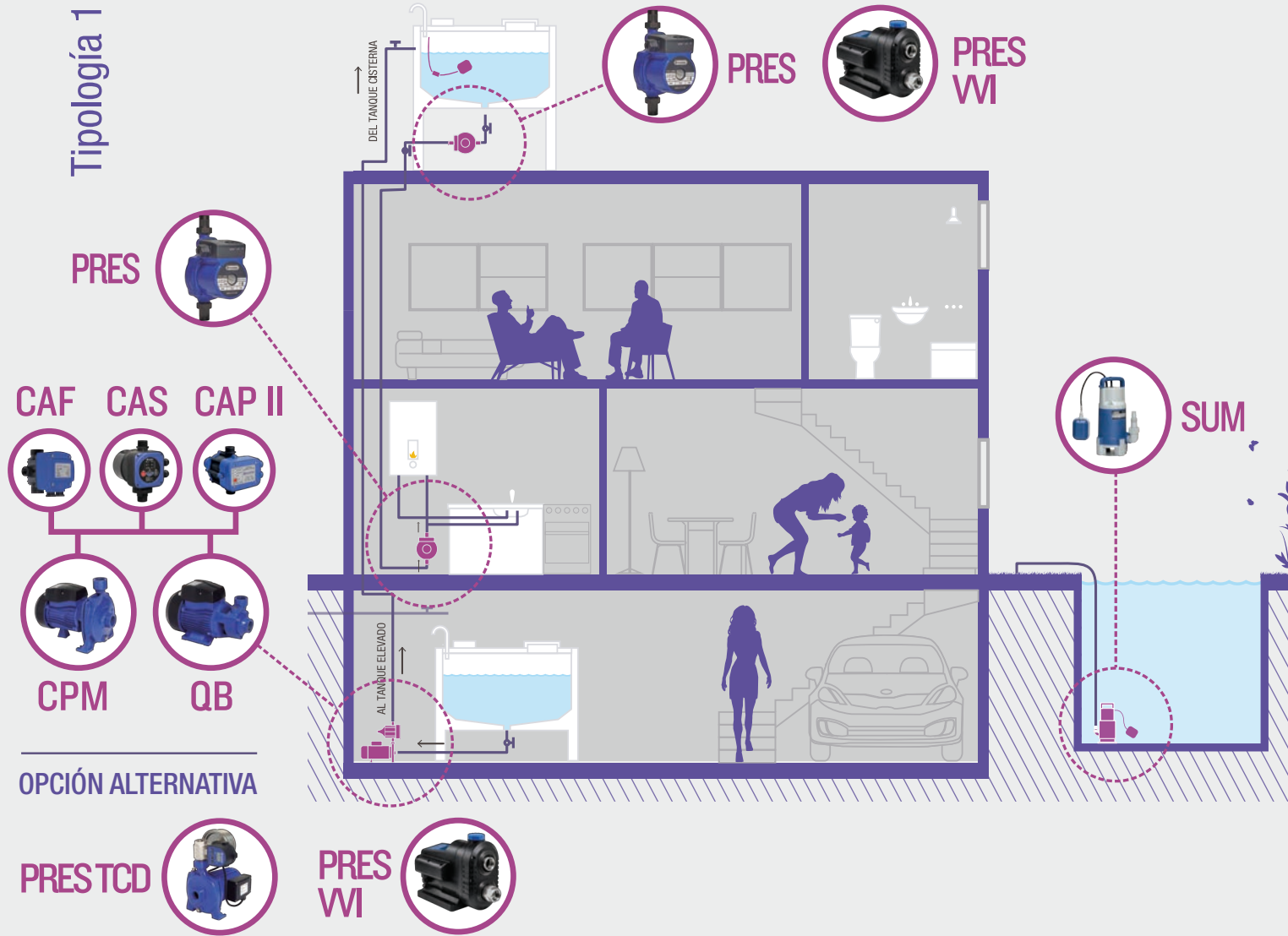

## Servicio técnico PLUVIUS. Respuesta rápida y confiable.

En Pluvius sabemos que un buen producto necesita un buen respaldo. Por eso contamos con un departamento técnico exclusivo, pensado para darte respuestas rápidas y soluciones reales ante cualquier consulta relacionada con:

- Instalación • Fallas técnicas • Garantía • Asesoramiento
- Repuestos legítimos

Otro canal de consulta es a través del sitio web, en la solapa de Servicio Técnico, donde completando un formulario podrá dejar asentado el reclamo y será contactado.



Asesoramiento Personalizado:  
+54 011 5263 0167

Asesoramiento Personalizado  
Vía WhatsApp:  
+54 11 6662 3227

Mail exclusivo:  
tecnica@latyn.net

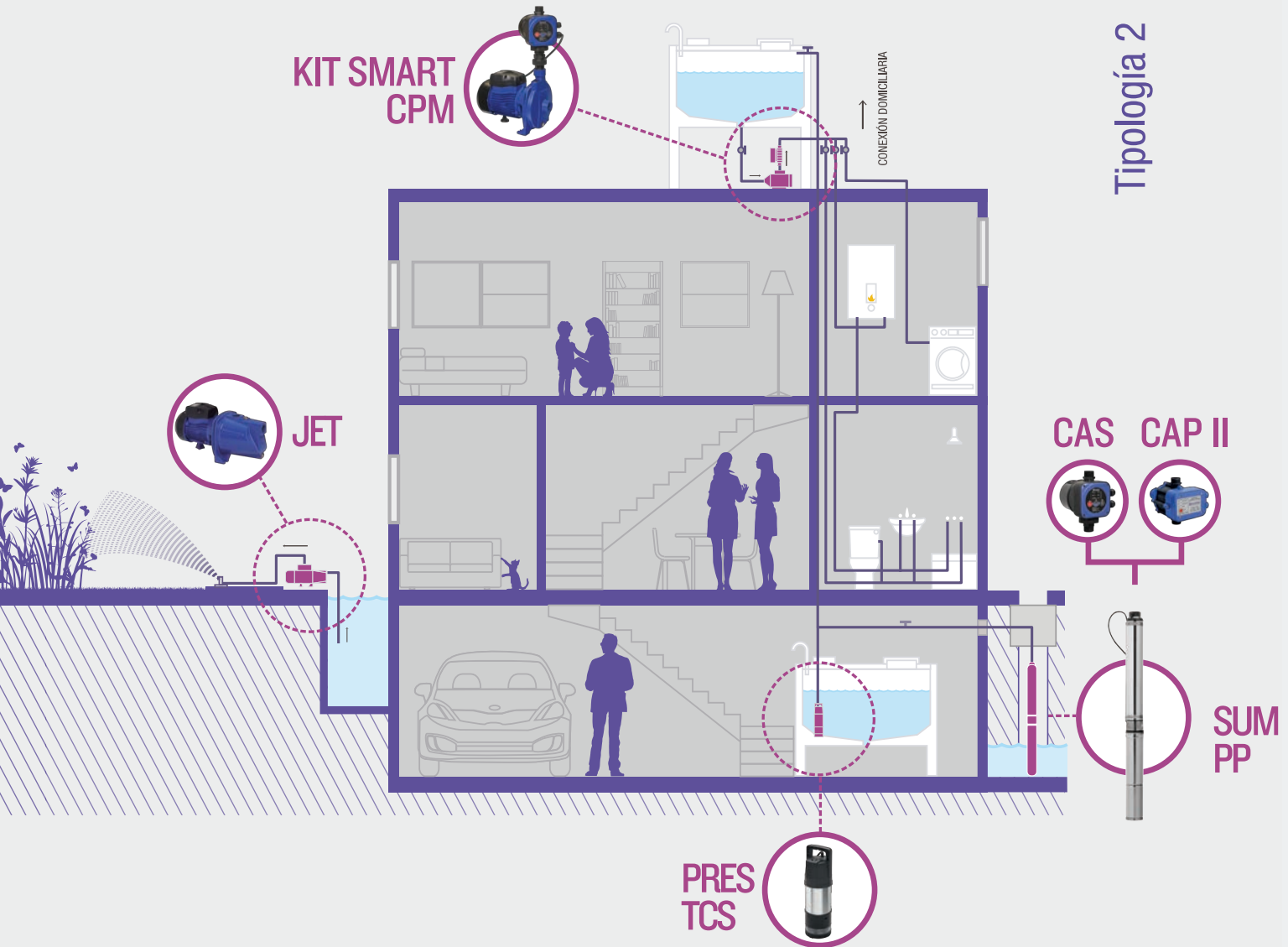

**Repuestos PLUVIUS.**  
Encontrá la línea más completa aquí.

**Garantía PLUVIUS**  
12 meses de tranquilidad asegurada.

Cuando elegís Pluvius, elegís rendimiento y también respaldo. Por eso, cada producto viene con 1 año de garantía, una promesa concreta de que estamos detrás de lo que fabricamos.

Porque la calidad no es solo lo que entregamos el día uno, sino el compromiso que sostenemos en el tiempo.

**Más que un producto: la tranquilidad de tener a Pluvius cuando lo necesitás.**



*Garantía de 1 año, siempre que se respeten las condiciones de uso y mantenimiento.*



## BOMBAS POZO PROFUNDO Y DESAGOTE

### BOMBA SUMERGIBLE PARA POZO PROFUNDO

#### TABLA DE CARACTERÍSTICAS

MODELO	SUM PP	CÓDIGO	ALTURA MAX. (m)	CAUDAL (l/h)	PROF. MAX. (m)	POTENCIA (hp)	CONEXIÓN (entrada y salida)
	1 HP	2344	63	6660	50	1	1 1/2"
	1,5 HP	2345	97	6660	50	1,5	1 1/2"
	2 HP	2346	124	6660	50	2	1 1/2"

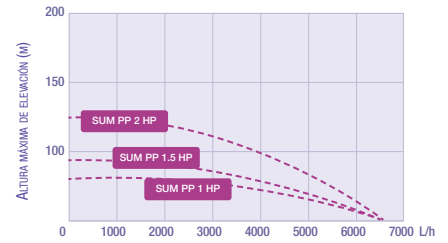

### BOMBA SUMERGIBLE PARA POZO PROFUNDO SLIM

#### TABLA DE CARACTERÍSTICAS

MODELO	SUM PPS	CÓDIGO	ALTURA MAX. (m)	CAUDAL (l/h)	PROF. MAX. (m)	POTENCIA (hp)	CONEXIÓN (entrada y salida)
	0,5 HP	2347	34	1692	50	0,5	1"
	0,75 HP	2348	43	1692	50	0,75	1"

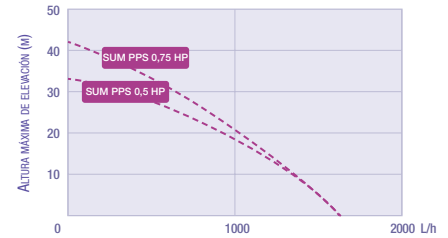

### BOMBA SUMERGIBLE PLÁSTICA

#### TABLA DE CARACTERÍSTICAS

MODELO	SUM	CÓDIGO	TIPO DE AGUA	ALTURA MAX. (m)	CAUDAL MAX. (m)	POTENCIA (w)
	L 400	2311	Limpia	8	7000	400
	L 550	2312	Limpia	8,5	11000	500
	S 400	2313	Sucia	5	8000	400
	S 750	2316	Sucia	8	13000	750

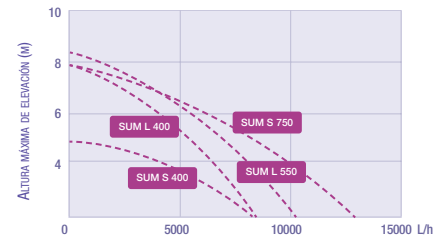

### BOMBA SUMERGIBLE ACERO INOX.

#### TABLA DE CARACTERÍSTICAS

MODELO	SUM	CÓDIGO	TIPO DE AGUA	ALTURA MAX. (m)	CAUDAL (m)	POTENCIA (w)
	S 900 A	2333	SUCIA	9	14000	900

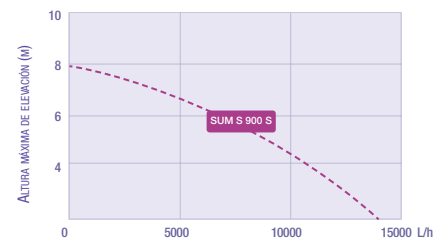

# NUEVOS KITS TODO EN UNO

## KIT PRES

QB 60  
CPM 146



## PRESURIZACIÓN

## ELEVACIÓN



## KIT SMART

QB 60  
CPM 146 / 158

- Compatibilidad asegurada • Garantía unificada
- Instalación express • Cero reclamos Post-Venta

KITS BOMBAS + CONTROLADORES

KIT PRESURIZADOR

TABLA DE CARACTERÍSTICAS

MODELO	KIT PRES	CÓDIGO	ALTURA MAX. (m)	CAUDAL (l/h)	SUCCIÓN MAX. (m)	POTENCIA (hp)	CONEXIÓN (entrada y salida)
	QB 60	2325	28	1980	5	0,5	1"
	CPM 146	2327	20	5400	8	0,75	1"

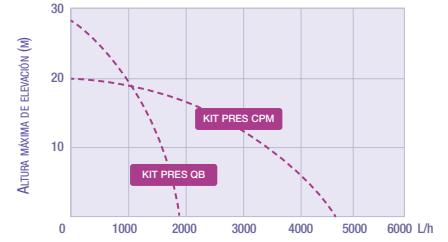

KIT ELEVADOR

TABLA DE CARACTERÍSTICAS

MODELO	KIT SMART	CÓDIGO	ALTURA MAX. (m)	CAUDAL (l/h)	SUCCIÓN MAX. (m)	POTENCIA (hp)	CONEXIÓN (entrada y salida)
	QB 60	2324	28	1980	5	0,5	1"
	CPM 146	2325	20	5400	8	0,75	1"
	CPM 158	2327	25	5700	8	1	1"

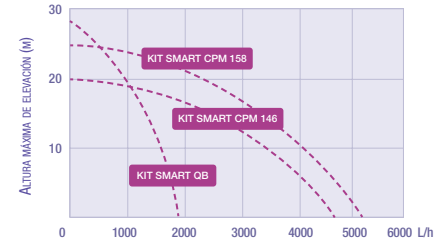

CONTROLADORES

CONTROL AUTOMÁTICO DE PRESIÓN

MODELO	CAP II	CÓDIGO	TEMP. MAX. DEL AGUA	PRESIÓN MAX. DE USO	CONEXIÓN (entr/salida)
		396	60°	10 BAR	1"



CONTROL AUTOMÁTICO DE FLUJO

MODELO	CAF	CÓDIGO	TEMP. MAX. DEL AGUA	PRESIÓN MAX. DE USO	CONEXIÓN (entr/salida)
		2340	60°	10 BAR	1"



CONTROL AUTOMÁTICO DE PRESIÓN SMART

MODELO	CAS	CÓDIGO	TEMP. MAX. DEL AGUA	PRESIÓN MAX. DE USO	CONEXIÓN (entr/salida)
		2340	80°	15 BAR	1"



CONTROL AUTOMÁTICO DE PRESIÓN DIGITAL

MODELO	CAD	CÓDIGO	TEMP. MAX. DEL AGUA	PRESIÓN MAX. DE USO	CONEXIÓN (entr/salida)
		396	80°	6 BAR	3/8"



CONTROLADOR AUTOMÁTICO DE NIVEL

MODELO	CAN	CÓDIGO	CONEXIÓN (entrada y salida)
		2340	1



**AUMENTANDO  
EL CAUDAL  
DE VENTAJAS**

**SISTEMAS DE  
TERMOFUSIÓN  
DE CONDUCCIÓN  
DE AGUA**



**LATYN-FUSIÓN**  
SISTEMA TERMOFUSIÓN DE CONDUCCIÓN DE AGUA

# HECHOS PARA DURAR

GARANTÍA  
DE CALIDAD  
POR MÁS  
DE 50 AÑOS



LAS TUBERÍAS DURAFLOW Y ECOFLOW  
CUENTAN CON SELLO IRAM



## TUBERÍAS Y ACCESORIOS

### TUBOS AGUA FRÍA ECOFLOW

MODELO	F-12	CÓD.	MED.
		722320	32x4,4
		722401	40x5,5
		722501	50x6,9



### TUBOS AGUA CALIENTE DURAFLOW

MODELO	F-20	CÓD.	MED.
		722220	20x2,8
		722225	25x3,5
		72232	32x4,4
		72240	40x5,5
		72250	50x6,9



### TUBOS AGUA CALIENTE THERMOFLOW

MODELO	F-22	CÓD.	MED.
		7212220	20x2,8
		7212225	25x3,5
		7212232	32x4,4
		7212240	40x5,5
		7212250	50x6,9
		7212263	63x8,6



### CODO 90°

MODELO	F-90	CÓD.	MED.
		729020	20
		729025	25
		729032	32
		729040	40
		729050	50
		729063	63
		729075	75



### CUPLA

MODELO	F-270	CÓD.	MED.
		7227020	20
		7227025	25
		7227032	32
		7227040	40
		7227050	50
		7227063	63
		7227075	75



### TEE

MODELO	F-130	CÓD.	MED.
		7213020	20
		7213025	25
		7213032	32
		7213040	40
		7213050	50
		7213063	63
		7213075	75



### TAPA

MODELO	F-301	CÓD.	MED.
		7230120	20
		7230125	25
		7230132	32
		7230140	40
		7230150	50
		7230163	63



### CODO 45°

MODELO	F-120	CÓD.	MED.
		7212020	20
		7212025	25
		7212032	32
		7212040	40
		7212050	50



### CURVA 90°

MODELO	F-41	CÓD.	MED.
		724120	20
		724125	25



**UNIÓN DOBLE**

MODELO	F-340	CÓD.	MED.
		7234020	20
		7234034	25
		723401	32
		7234040	40
		7234050	50
		7234063	63

**CUPLA C/INSERTO H**

MODELO	F-240 H	CÓD.	MED.
		722702038	20x3/8
		72270201	20x1/2
		72270251	25x1/2
		72270252	25x3/4
		72270321	32x1
		722704001	40x11/4
		72270050112	50x11/2
		722700632	63x2

**CUPLA C/INSERTO M**

MODELO	F-240 M	CÓD.	MED.
		72270203	20x1/2
		72270253	25x1/2
		72270254	25x3/4
		72270324	32x3/4
		72270323	32x1
		72270400	40x11/4
		7227050112	50x11/2
		72270632	63x2

**CODO C/INSERTO H**

MODELO	F-90H	CÓD.	MED.
		7290201	20x1/2
		7290202	20x3/4
		7290251	25x1/2
		7290252	25x3/4
		7290321	32x3/4
		7290322	32x1

**CODO C/INSERTO M**

MODELO	F-90 M	CÓD.	MED.
		7290203	20x1/2
		7290254	25x1/2
		7290253	25x3/4
		7290324	32x1
		72270632	72270632

**TEE C/INSERTO H**

MODELO	F-130 H	CÓD.	MED.
		72130201	20x1/2
		72130251	25x1/2
		72130252	25x3/4
		72130321	32x3/4
		721360322	32x1

**TEE C/INSERTO M**

MODELO	F-130 M	CÓD.	MED.
		72130203	20x1/2
		721302512	25x1/2
		721302534	25x3/4
		721303234	32x3/4
		721300321	32x1

**UNIÓN DOBLE C/INSERTO H**

MODELO	F-340 H	CÓD.	MED.
		72340201	20x1/2
		72340251	25x3/4
		72340321	32x1

**UNION DOBLE C/INSERTO M**

MODELO	F-340 M	CÓD.	MED.
		72340202	20x1/2
		72340252	25x3/4
		72340322	32x1
		7234040114	40x11/4

**CUPLA REDUCCIÓN**

MODELO	F-240 R	CÓD.	MED.
		722702520	25x20
		722703220	32x20
		722703225	32x25
		722704020	40x20
		722704025	40x25
		722704032	40x32
		722705032	50x32
		722705040	50x40
		722706340	63x40
		722706350	63x50
		722707563	75x63

**BUJE REDUCCIÓN**

MODELO	F-241 R	CÓD.	MED.
		722412520	25x20
		722413225	32x25

**TEE REDUCCIÓN**

MODELO	F-130 R	CÓD.	MED.
		72130252025	25x20
		72130322032	32x20
		72130322532	32x25
		72130402540	40x25
		72130403240	40x32
		72130503250	50x32
		72130504050	50x40
		72130634063	63x40
		72130635063	63x50

**CODO 90° REDUCCIÓN**

MODELO	F-90R	CÓD.	MED.
		72902520	25x20
		72903220	32x20
		72903225	32x25

**SOBREPASO CORTO**

MODELO	F-55	CÓD.	MED.
		520	20
		525	25
		532	32

**SOBREPASO**

MODELO	F-50	CÓD.	MED.
		725020	20
		725025	25
		725032	32

VÁLVULAS Y LLAVES DE PASO

LLAVE DE PASO PPR CABEZAL BRONCE

MODELO	F-70	CÓD.	MED.
		7270020	20
		7270025	25
		7270032	32



LLAVE DE PASO TOTAL PPR

MODELO	F-80	CÓD.	MED.
		7280020	20
		7280025	25
		7280032	32



LLAVE DE PASO PPR CABEZAL POLIAMIDA

MODELO	F-60	CÓD.	MED.
		7260020	20
		7260025	25
		7260032	32



VÁLVULA FUSIÓN PPR ESFERA PLÁSTICA

MODELO	JS-1700	CÓD.	MED.
		570020	20
		570025	25
		570032	32

Fabricada en PPR, con bola de PVC.



VÁLVULA FUSIÓN PPR ESFERA METÁLICA

MODELO	JS-1800	CÓD.	MED.
		580020	20
		580025	25
		580032	32
		580040	40
		580050	50
		580063	63

Fabricada en PPR, con bola de acero cromado.



VAL. CIERRE ESFÉRICA PPR

MODELO	JS-1900	CÓD.	MED.
		590020	20
		590025	25
		590032	32
		590040	40
		590050	50
		590063	63

Fabricada en PPR, con bola de acero cromado.



VAL. ESFÉRICA DOBLE MEDIA UNIÓN

MODELO	JS-2000	CÓD.	MED.
		520020	20
		520025	25
		520032	32
		520040	40
		520050	50
		520063	63

Fabricada en PPR, con bola de PVC.



VÁLVULA ESFÉRICA FUSIÓN VÁSTAGO CORTO

MODELO	RF-FUSION C	CÓD.	MED.
		13520	20-1/2
		13525	25-3/4
		13532	32-1
		13540	40-1 1/4
		13550	50-11/2
		13563	63-2

Fabricada en bronce, con bola de bronce.



HERRAMIENTAS SANITARIAS

FIJATUBO PPR

MODELO	FIJ-PPR	CÓD.	MED.
		7270201	20
		7270252	25
		7270321	32



FIJATUBO METÁLICO

MODELO	FIJ-MET	CÓD.	MED.
		727020	20
		727025	25
		727032	32



BOMBA MANUAL PARA PRUEBA DE PRESIÓN

MODELO	BM-800	CÓDIGO	PRESIÓN
		3580025	25kg
		3580040	40kg



TIJERA CORTA TUBOS

MODELO	CT-3201	CÓDIGO	MEDIDA
		35203201	42mm



TIJERA CORTATUBO PRO

MODELO	CT-3210	CÓDIGO	MEDIDA
		35203210	-



CORTA TUBOS PROFESIONAL

MODELO	CT-3205	CÓDIGO	MEDIDA
		35203205	42mm
		35203206	42mm

REPUESTO PARA CT 3205



KIT TERMOFUSORA 800W

MODELO	TF-5006	CÓDIGO	POTENCIA
		35235006	800w

Incluye boquillas 20/25/32/40/50/63"



KIT TERMOFUSORA 1500W

MODELO	TF-5009	CÓDIGO	POTENCIA
		35235009	1500w

Incluye boquillas 20/25/32/40/50/63"



BOQUILLA TEFLONADA MILIMÉTRICA

MODELO	TF-5020	CÓD.	MED.
		35235011	20mm
		35235012	25mm
		35235013	32mm
		35235014	40mm
		35235015	50mm
		35235016	63mm



# DT LATYN-FUSIÓN

## DEPARTAMENTO TÉCNICO

### Asesoramiento, Cómputo, Servicio Post Venta y Garantía certificada

Latyn Fusión pone a disposición de sus clientes el DT Latyn-Fusión (Departamento Técnico), un equipo de profesionales especializados para acompañar cada etapa del proyecto. Desde el diseño hasta la ejecución en obra, brinda asesoramiento personalizado, selección de componentes y cómputo detallado de materiales, garantizando soluciones precisas y eficientes para instalaciones residenciales, comerciales e industriales.

Un sólido respaldo post venta y una garantía certificada por 50 años de vida útil avalan la calidad y durabilidad del sistema, ofreciendo tranquilidad a instaladores y usuarios finales, con un equipo siempre disponible para dar respuesta ágil ante cualquier consulta o situación que lo requiera.



#### SERVICIO POSTVENTA

LATYNFUSIÓN brinda un servicio de postventa exclusivo para instaladores, con asesoramiento tanto en el cómputo como en la instalación en obra.

#### CERTIFICADO DE GARANTÍA

LATYNFUSIÓN otorga una garantía certificada por 50 años de vida útil.

#### ALCANCE DE LA GARANTÍA

La garantía se refiere a la sustitución de la pieza fallada ante defectos de material o de producción, reconocidos exclusivamente por nuestra oficina de Servicio Técnico, siempre que la instalación y el mantenimiento se hayan realizado adecuadamente, no haya habido mal uso o maltrato, ni intento de reparación no autorizado adecuadamente, ni quita y/o agregado de componentes extraños, ni daños y/o averías producidas durante el transporte, ni enmiendas a la factura o falsedad de datos. La garantía no cubre los gastos vinculados, flete y seguro, desde y hacia nuestra oficina de Servicio Técnico.

#### LÍMITE DE LA GARANTÍA

La garantía cubre exclusivamente la sustitución de la pieza por una de iguales prestaciones, o superiores si no hubiera disponibilidad de la misma, y según lo dictamine nuestra oficina de Servicio Técnico. En ningún caso se contemplarán cargos indemnizatorios de ninguna índole, gastos asociados de la obra, mano de obra y/o materiales por perjuicios ocasionados por fallas.

Previo a la instalación, recomendamos verificar cuidadosamente el estado del material, el de los otros elementos empleados y el cumplimiento de las prácticas habituales de instalación reconocidas.

#### CONTACTO LATYN

Ante cualquier consulta técnica sobre nuestra línea de productos contáctenos a:

[Info@latyn.net](mailto:Info@latyn.net)



#SiempreLatyn  
[latynconexiones.com.ar](http://latynconexiones.com.ar)

